



N1040T Controller

TEMPERATURE CONTROLLER AND TIME – INSTRUCTIONS MANUAL – V2.1x H

SAFETY ALERTS

The symbols below are used on the equipment and throughout this document to draw the user's attention to important operational and safety information.

CAUTION: Read the manual thoroughly before installing and operating the equipment.	CAUTION OR DANGER: Electrical shock hazard

All safety related instructions that appear in the manual must be observed to ensure personal safety and to prevent damage to either the instrument or the system. If the instrument is used in a manner not specified by the manufacturer, the protection provided by the equipment may be impaired.

INSTALLATION / CONECTIONS

The controller must be fastened on a panel, following the sequence of steps described below:

- Prepare a panel cut-out according Specifications;
- Remove the mounting clamps from the controller;
- Insert the controller into the panel cut-out;
- Slide the mounting clamp from the rear to a firm grip at the panel.

ELECTRICAL CONNECTIONS

Fig. 01 below shows the electrical terminals of the controller:

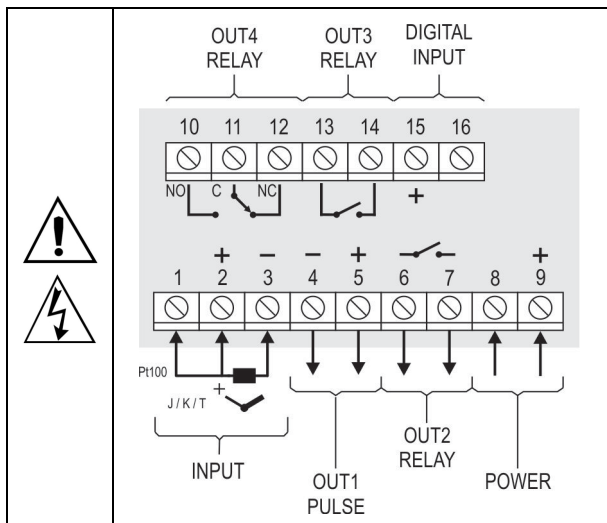

Fig. 01 - Connections of the back panel

RECOMMENDATIONS FOR THE INSTALLATION

- All electrical connections are made to the screw terminals at the rear of the controller.
- To minimize the pick-up of electrical noise, the low voltage DC connections and the sensor input wiring should be routed away from high-current power conductors. If this is impractical, use shielded cables. In general, keep cable lengths to a minimum.
- All electronic instruments must be powered by a clean mains supply, proper for instrumentation.
- It is strongly recommended to apply RC'S FILTERS (noise suppressor) to contactor coils, solenoids, etc. In any application it is essential to consider what can happen when any part of the system fails. The controller features by themselves cannot assure total protection.

FEATURES

INPUT TYPE SELECTION

Table 01 shows the sensor types accepted and their respective codes and ranges. Access the parameter **TYPE** in the INPUT cycle to select the appropriate sensor.

TYPE	CODE	RANGE OF MEASUREMENT
Thermocouple J	tc J	Range: -110 to 950 °C (-166 to 1742 °F)
Thermocouple K	tc K	Range: -150 to 1370 °C (-238 to 2498 °F)
Thermocouple T	tc T	Range: -160 to 400 °C (-256 to 752 °F)
Pt100	Pt	Range: -200 to 850 °C (-328 to 1562 °F)

Table 01 – Input types

DIGITAL INPUT (DIG IN)

Available at terminals 15th and 16th on the back panel of the controller. Detects the closing of dry contact switches.

The A3 indicator lamp shows the condition of the Digital Input:

- On = DI Actioned (contact closed)
- Off = DI Not Actioned (contact open)

OUTPUTS

The controller offers two or four output channels, depending on the loaded optional features. The output channels are user configurable as **Control Output**, **Output Timers (T1)**, **Output Timers (T2)**, **Alarm Output 4**.

OUT1 - Logical pulse, 5 Vdc / 25 mA, available at terminals 4 and 5 of the controller.

OUT2 - Relay SPST-NA. Available at terminals 6 and 7.

OUT3 - Relay SPST-NA. Available at terminals 13 and 14.

OUT4 - Relay SPDT, available at terminals 10, 11 and 12.

TEMPERATURE CONTROL OUTPUT

The process control output can operate in **ON/OFF** mode or in **PID** mode. To operate in **ON/OFF**, mode the value defined in the parameter **Pb** should be **0.0**. The control strategy can be **ON/OFF** (when **Pb = 0.0**) or **PID**. The PID parameters can be automatically determined enabling the auto-tuning function (**Autun**).

ALARM OUTPUT

The controller has an alarm that can be configured to operate on any of the output channels. It can be configured to operate in one of the different functions as detailed in **Table 02**.

oFF	Alarm disabled.	
Lo	Alarm of Absolute Minimum Value. Triggers when the value of measured PV is below the value defined for alarm Setpoint (SPA4).	
Hi	Alarm of Absolute Maximum Value. Triggers when the value of measured PV is above the value defined for alarm Setpoint.	
dIF	Alarm of Differential Value. In this function the parameter "SPA4" represent the deviation of PV in relation to the SP of control.	
		Positive SPA4 Negative SPA4
dIFL	Alarm of Minimum Differential Value. It triggers when the value of PV is below the defined point by (using the alarm 1 as example).	
		Positive SPA4 Negative SPA4
dIFH	Alarm of Valor Maximum Differential Value. Triggers when the value of PV is above the defined point by SP+SPA4.	
		Positive SPA4 Negative SPA4
iErr	Alarms of the Sensor Break (Sensor Break Alarm). It is activated when the Input presents problems such as interrupted sensor, bad connection, etc.	

Table 02 – Alarm functions

Important note: Alarms configured with the **Hi**, **dIF**, and **dIFH** functions also trigger their associated output when a sensor fault is identified and signaled by the controller. A relay output, for example, configured to act as a High Alarm (**Hi**), will operate when the SPAL value is exceeded and also when the sensor connected to the controller input is broken.

INITIAL BLOCKING OF ALARM

The option to Block initial alarms inhibits the alarms in the case that there is an alarm condition present on startup. The alarm will be enabled only after the occurrence of a non-alarm condition.

Initial Blocking is useful, for example, in the initialization of process control operations when the value of the PV is still far from the SP value. Hence the system waits for alarm situations and unwanted alarms are avoided.

The initial blocking is disabled for the sensor break alarm function **iErr**.

OFFSET

Allows fine adjustments to the PV reading for compensation of sensor error. Offset allows measurements errors to be corrected when the occur, for example after the substitution of a temperature sensor.

FUNCTION LBD – LOOP BREAK DETECTION

The parameter defines a time interval, in minutes, within which the PV is expect to react to a control output signal. If the PV does not react properly within the time interval configured in **Lbdt**, the controller interprets this as a control loop break and signals this occurrence in the display.

If the **Lbdt** parameter is set to 0 (zero) then this function is disabled.

This function allows the user to detect problems in the installation, for example an actuator with a defect, a failure of supply power, etc.

A LBD event may be sent to any output channel. Simply configure the LBD function to the desired output channel (OUT1 or OUT2): the selected output will be activated when a LBD condition is detected. When the **Lbdt** parameter is programmed with 0 (zero), the LBD function is disabled.

The LBD is useful in detecting system failures, such us defective sensors or actuators, loads and power supply, among others.

SAFE OUTPUT VALUE WITH SENSOR FAILURE

This function defines an output value (user defined) to be assigned to the control output in the event of a sensor failure.

When the input sensor is identified as broken, the controller switches the control mode to MANUAL while forcing MV to assume the user configured value in the **iEou** parameter. This function requires that one of the alarms be configured as **iErr** and the **iEou** parameter (control output percentage) programmed with a value other then 0 (zero).

Once this function is triggered, the controller remains in SAFE mode (MANUAL control output) even after the sensor failure appears to be fixed. The operator intervention is required for switching back to AUTO mode.

iEou values are only 0 and 100 % when in ON/OFF control mode. For PID control mode any value in the range from 0 to 100 % is accepted.

USB INTERFACE

The USB interface is used for CONFIGURING or MONITORING the controller. The **NConfig** software must be used for the configuration. It makes it possible to create, view, save and open configurations from the equipment or files in your computer. The tool for saving and opening configurations in files makes it possible to transfer configurations between pieces of equipment and to make backup copies. For specific models, the **NConfig** software also makes it possible to update the firmware (internal software) of the controller through the USB.

For MONITORING purposes you can use any supervisory software (SCADA) or laboratory software that supports the MODBUS RTU communication on a serial communications port. When connected to the USB of a computer, the controller is recognized as a conventional serial port (COM x). Use the **NConfig** software or consult the DEVICE MANAGER in the Windows CONTROL PANEL to identify the COM port that was assigned to the controller. Consult the mapping of the MODBUS memory in the controller's communications manual and the documentation of your supervisory software to conduct the MONITORING process.

Follow the procedure below to use the USB communication of the equipment:

1. Download the **NConfig** software from our website and install it on your computer. The USB drivers necessary for operating the communication will be installed together with the software.
2. Connect the USB cable between the equipment and the computer. The controller does not have to be connected to a power supply. The USB will provide enough power to operate the communication (other equipment functions cannot operate).
3. Open the **NConfig** software, configure the communication and start recognition of the device.

 	<p>The USB interface IS NOT SEPARATE from the signal input (PV) or the controller's digital inputs and outputs. It is intended for temporary use during CONFIGURATION and MONITORING periods. For the safety of people and equipment, it must only be used when the piece of equipment is completely disconnected from the input/output signals. Using the USB in any other type of connection is possible but requires a careful analysis by the person responsible for installing it. When MONITORING for long periods of time and with connected inputs and outputs, we recommend using the RS485 interface.</p>
------	---

TIMERS

This controller contains two timers that can operate independently of the control output.

T1 TIMER

The T1 timer is the main timer. Its time interval is defined in minutes: seconds (MM:SS) and allows various operating modes:

There are four starting modes for T1:

- RUN** T1 starts when the control outputs are enabled (RUN= YES).
- SP** T1 starts when the PV value reaches the SP value.
- F** starts upon pressing the **F** key. Once the timer is initiated, pressing again the **F** key stops and resets the timer. Pressing the **F** key once more, a new timer cycle takes place.
- DI** T1 starts upon command of the Digital Input (dry contact). The timer is triggered on a high signal from the DI (closed contact) and the timing starts. If the DI goes low (open contact) before the end of the timer, the timer is interrupted and a new cycle will start when a new high signal is received on the DI.

Releasing the Digital Input while the timer is running causes T1 to stop and reset. Closing again the Digital Input initiates a new timer cycle.

Note: If the run parameter has been manually set to NO (control disabled), the options to trigger via the **F** key and DI do not permit the reactivation of control (RUN= YES). If RUN=NO (control output disabled), the timer remains disabled regardless of the **F** key and Digital Input commands.

Operating Modes of Timer T1

The T1 timer has three different modes of operation. The modes of operation define the behavior of the outputs associated with the timer. The T1 timer can be associated to any of the outputs OUT1, OUT2, OUT3 and OUT4, whose behavior can be configured to work in three distinct modes:

- off** The output of T1 is turned **Off** the end of T1. Output turns on when timer starts and turns off when the time defined in T1 has elapsed.
The A1 sign remains lit while the timer is running and flashes after the T1 interval is completed.
- on** The output of T1 is turned **On** at the end of T1. Output remains off during the timer interval and turns on at its end, remaining so until the start of a new timer cycle.
The A1 sign flashes during the whole timer duration and it is turned on continuously after the timer is elapsed, indicating that the Output is ON.
- onH** The output of T1 **Stays On** at the end of T1. Output is turned on at the beginning of the timer cycle and remains in this state even after the timer has elapsed.
The A1 sign is lit during the time counting and flashes at the end of the temporization, indicating that the output is ON.

T2 TIMER

T2 is the secondary timer and is activated at the end of T1. The T2 output can be associated to any free controller output. This output remains ON during the whole T2 duration.

The indicator A2 indicates the condition of timer T2:

- T2 is running, A2 is on.
- T2 has not started or has already finished, A2 is off.

UP/DOWN TIMER COUNTING

Both timers can be configured to display the counting in incrementing (UP) or decrementing (DOWN) modes. In UP mode, the counting starts at zero and counts up until the time setting is reached. In DOWN mode, the display starts showing the time setting and counts down to zero.

TEMPERATURE CONTROL OUTPUT DURING TIMER OPERATION

During the T1 and T2 operation the control output works normally. However, the behavior of the control output can be configured to stop after the time T1 + T2 has elapsed, forcing RUN=NO. See the description of the parameter **LECO** in the timing cycle of the controller.

TIME BASE OF THE TIMERS

The parameter **LBAS** at the end of the timing cycle defines the time base that will be used. The options are:

- SEc** MM:SS. The intervals of T1 and T2 are presented in minutes and seconds.
- HH** HH:MM. The intervals of T1 and T2 are presented in hours and minutes.

OPERATION

The controller's front panel, with its parts, can be seen in the **Fig. 02**:

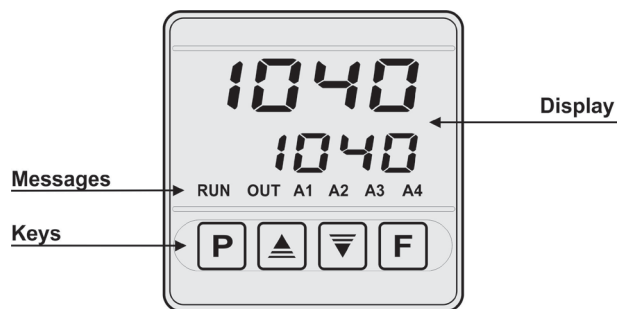

Fig. 02 – Front panel

Display: Shows the measured variable, symbols of the configuration parameters and their values / conditions.

TUNE Indicator: Stays ON while the controller is in tuning process.

RUN Indicator: Controller On.

OUT Indicator: For relay or pulse control output; it reflects the actual state of the output.

Indicator A1: Indicates the T1 Timer Output Condition.

Indicator A2: Indicates the T2 Timer Output Condition.

Indicator A3: Indicates the Digital Input Condition.

Indicator A4: Indicates the Alarm 4 status.

P Key: Used to walk through the menu parameters.

▲ Increment key and ▼ - Decrement key: Allow altering the values of the parameters.

⏪ Key: Key used to move backwards the parameter list during setup.

STARTUP

When the controller is powered up, it displays its firmware version for 3 seconds, after which the controller starts normal operation. The value of PV and SP is then displayed and the outputs are enabled. It is in the lower display that the value of SP is displayed. This is the **Indication Screen**.

In order for the controller to operate properly in a process, its parameters need to be configured first, such that it can perform accordingly to the system requirements. The user must be aware of the importance of each parameter and for each one determine a valid condition.

The parameters are grouped in levels according to their functionality and operation easiness.

Operation / Tuning / Timers / Alarms / Input / Calibration

The "P" key is used for accessing the parameters within a level.

Keeping the "P" key pressed, at every 2 seconds the controller jumps to the next level of parameters, showing the first parameter of each level:

PV >> RUN >> T1 >> FUR4 >> TYPE >> PASS >> PV ...

To enter the desired cycle, just drop the **P** key as its first parameter show up. To move forward on the parameters of this cycle, use the **P** key with short touches. At the end of each cycle, the controller returns the Indication Screen.

Each parameter has its symbol on the upper display while its value / condition is on the lower display.

DESCRIPTION OF THE PARAMETERS

OPERATION CYCLE

PV + SP	PV Indication screen. On the higher display (red) the value of the measured variable (PV) temperature is shown. On the lower display (green), the control setpoint (SP) is shown.
PV + TM	Display PV and decreasing time. The upper display (red) shows the measured temperature value (PV). In the lower display (green) the current count of the timer defined as Timer 1 is displayed. You cannot set this display.
t1 Timer 1	Set the T1 time interval. From 00:00 to 99:59 (HH:MM or MM:SS). Parameter showed in this cycle when defined in tEn .
SP, A4	Alarm SP: Value that defines the point of activation of the alarm outputs. For the alarms programmed with the functions of the type Differential , these parameters represent the deviations. Parameter shown in this level only when enabled in the parameter SP4.E .
run Run	Display for enable or disable the controller's action on the process. It acts like a switch, turning the controller on or off. YES Outputs enabled no Output disabled Parameter showed in this cycle when defined in run.E .

TUNING CYCLE

Autun Auto-tune	AUTO-TUNE: enables the auto-tuning function for the PID parameters (Pb , Ir , dt). Consult the chapter Determination of PID Parameters in this manual and on the website www.novusautomation.com for more details. Defines the control strategy to be taken: oFF - Turned off. (no PID tuning) FRSt - Automatic tuning. Fu l l - More accurate automatic tuning.
Pb Proportional Band	Proportional Band - Value of the term P of the control mode PID, in percentage of the maximum span of the input type. Adjust of between 0 and 500.0 %. When set to zero (0), control action is ON/OFF.
Ir Integral Rate	Integral Rate - Value of the term I of the PID algorithm, in repetitions per minute (Reset). Adjustable between 0 and 24.00. Displayed only if proportional band ≠ 0.
dt Derivative Time	Derivative Time - Value of the term D of the control mode PID, in seconds. Adjustable between 0 and 250 seconds. Displayed only if proportional band ≠ 0.
t Cycle Time	Cycle time: Pulse Width Modulation (PWM) period in seconds. Adjustable between 0.5 and 100.0 seconds. Displayed only if proportional band ≠ 0.
HYS Hysteresis	Control hysteresis: Is the hysteresis for ON/OFF control. This parameter is only used when the controller is in ON/OFF mode. Adjustable between 0 and the bandwidth of measurement of the input type selected. Displayed only if proportional band Pb = 0.

Act Action	Action Control: rE Control with Reverse Action . Appropriate for heating . Turns control output on when PV is below SP. d Ir Control with Direct Action . Appropriate for cooling . Turns control output on when PV is above SP.
SFS Softstart	SoftStart Function – Time interval, in seconds, while the controller limits the control output (MV) rising rate. From 0 to 9999 s. (zero value disables the Soft start function).
Out 1 Out 2 Out 3 Out 4	Assign functions to the Output channels OUT1, OUT2, OUT3 e OUT4: oFF Not used. Ctrl Acts as a temperature controller. Control output. A4 Alarm 4 output. Lbd Acts as an output for the LBD function. Loop Break Detect Alarm. t1 T1 timer output. t2 T2 timer output.

TIMER CYCLE

t1	T1 time interval setting, 00:00 to 99:59 (MM:SS or HH:MM).
tEn Timer Enable	Allows the display of the T1 parameter in the main (operating) cycle. YES Shows t1 in the operating cycle. no Hides t1 from the operating cycle.
Ed Ir	Counting direction of T1 timer. UP - Up counting, starting from zero. dn - Down counting.
tSt Timer Start	Defines starting mode for T1 timer. d i Starts and resets timer through the Digital Input. F Starts, stops and resets timer using the F key. SP When PV reaches SP run By toggling run to YES
tEnd Timer End	Output behavior of T1 timer: oFF Output is turned off at the end of the time interval. on Output is turned on at the end of the time interval onH Output remains on after the timer has elapsed.
tECO Timer End Control Off ?	Control output behavior after the interval T1 + T2 . YES Control output is deactivated at the end of the timer (RUN= no). Control output is disabled. no Control output remains active.
t2 Timer 2	T2 time interval setting, 00:00 to 99:59 (MM:SS or HH:MM). T2 is activated at the end of T1 . Interval of time where the output T2 remains on after the end of timer T1 .
tBAS time base	Time base for the timers T1 and T2. h m Hours and Minutes (HH:MM) SEc Minutes and Seconds (MM:SS)

ALARMS CYCLE

FAF4 <i>Function Alarm</i>	Functions of Alarms. Defines the functions for the alarms among the options of the Table 02 .
SPR4	Alarm SP: Value that defines the point of activation of the alarm outputs. For the alarms programmed with the functions of the type Differential , these parameters represent the deviations. For the IErr alarm function, this parameter has no meaning.
SP4E	SP Enable . Configures display of SPR4 also in the Operation Cycle. YES - SPR4 is displayed in the Operation Cycle. no - SPR4 is not displayed in the Operation Cycle.
BLR4 <i>Blocking Alarm</i>	Initial Blocking of Alarm 4. Blocking Alarms. YES Enables initial blocking no Inhibits initial blocking
HYR4 <i>Histeresis of Alarm</i>	Alarm Hysteresis. Defines the difference between the value of PV at which the alarm is triggered and the value at which it is turned off.
FLSh <i>Flash</i>	Allows visual signalization of an alarm occurrence by flashing the indication of PV in the operation level. YES Enables alarm signaling flashing PV no Disables alarm signaling flashing PV

INPUT CYCLE

TYPE <i>Type</i>	Input Type : Selects the input signal type to be connected to the process variable input. J: tc J -110 to 950 °C / -166 to 1742 °F K: tc K -150 to 1370 °C / -238 to 2498 °F T: tc t -160 to 400 °C / -256 to 752 °F Pt100: Pt -200 to 850 °C / -328 to 1562 °F
FLtr <i>Filter</i>	Digital Input Filter - Used to improve the stability of the measured signal (PV). Adjustable between 0 and 20. In 0 (zero) it means filter turned off and 20 means maximum filter. The higher the filter value, the slower is the response of the measured value.
dPPO <i>Decimal Point</i>	Selects the decimal point position to be viewed in both PV and SP.
unit <i>Unit</i>	Selects display indication for degrees Celsius or Fahrenheit: °F Indication in Fahrenheit. °C Indication in Celsius.
OFFS <i>Offset</i>	Parameter that allows the user to make adjustments to the PV value indicated. Sensor Offset: Offset value to be added to the PV reading to compensate sensor error. Default value: zero.
SPLL <i>SP Low Limit</i>	Defines the SP lower limit of.
SPHL <i>SP High Limit</i>	Defines the upper limit for adjustment of SP.
LbdL <i>Loop break detection time</i>	Time interval for the LBD function. Defines the maximum interval of time for the PV to react to a control command. In minutes.
IEou	Percentage value to be applied to the output on any failure of the sensor that is connected to the controller input.

CALIBRATION CYCLE

All types of input are calibrated in the factory. In case a recalibration is required; it shall be carried out by a specialized professional. In case this cycle is accidentally accessed, do not perform alteration in its parameters.

PASS	Password. This parameter is presented before the protected cycles. See item Protection of Configuration.
CALib	Calibration. Enables the possibility for calibration of the indicator. When the calibration is not enabled, the related parameters are hidden.
InLC	Input Low Calibration. Enter the value corresponding to the low scale signal applied to the analog input.
InHC	Input High Calibration. Enter the value corresponding to the full scale signal applied to the analog input.
rStr	Restores the factory calibration of the input, discarding all alterations made by the user.
CJ	Cold Junction. Temperature of the Cold Junction of the controller. This screen is for information purpose only.
PASC	Password Change. Allows defining a new access password, always different from zero.
Prot	Protection. Sets up the Level of Protection. See Table 04 .
runE <i>RUN Enable</i>	Shows the parameter RUN (run) also in the Operation Cycle. YES Releases RUN for the operation cycle no Does not release RUN for the operation cycle
run <i>Run</i>	Display for enable or disable the controller's action on the process. It acts like a switch, turning the controller on or off. YES Outputs enabled no Output disabled
SnH <i>Serial Number</i>	Shows the first four digits electronic serial number of the controller.
SnL <i>Serial Number</i>	Shows the last four digits electronic serial number of the controller.

CONFIGURATION PROTECTION

The controller provides means for protecting the parameters configurations, not allowing modifications to the parameters values, avoiding tampering or improper manipulation. The parameter **Protection (Prot)**, in the Calibration level, determines the protection strategy, limiting the access to particular levels, as shown by the **Table 04**.

PROTECTION LEVEL	PROTECTION LEVELS
1	Only the Calibration level is protected.
2	Calibration and Input levels are protected.
3	Calibration, Input and Alarms levels are protected.
4	Calibration, Input, Alarms and Tuning levels are protected.
5	Tuning cycles, Timers, Alarming, Input and Calibration are protected. All levels are protected, but the SP screen in the operation level.
6	All levels are protected, including SP.

Table 04 – Levels of Protection for the Configuration

ACCESS PASSWORD

The protected levels, when accessed, request the user to provide the **Access Password** for granting permission to change the configuration of the parameters on these levels. The access password is entered in the parameter **PRSS** that is show in the first protected cycle.

The prompt **PRSS** precedes the parameters on the protected levels. If no password is entered, the parameters of the protected levels can only be visualized.

The Access Password is defined by the user in the parameter **Password Change (PRSC)**, present in the Calibration Level. **The factory default for the password code is 1111.**

PROTECTION ACCESS PASSWORD

The controller provides a system of security that helps to prevent the entering of many passwords in the hope of finding the correct one. The protection system built into the controller blocks for 10 minutes the access to protected parameters after 5 consecutive incorrect attempts at guessing the correct password.

MASTER PASSWORD

The Master Password is intended for allowing the user to define a new password in the event of it being forgotten. The Master Password doesn't grant access to all parameters, only to the **Password Change** parameter (**PRSC**). After defining the new password, the protected parameters may be accessed (and modified) using this new password.

The master password is made up by the last three digits of the serial number of the controller **added** to the number 9000. As an example, for the equipment with serial number 07154321, the master password is **9321**.

Controller serial number is displayed by pressing  for 5 seconds.

DETERMINATION OF PID PARAMETERS

During the process of determining automatically the PID parameters, the system is controlled in **ON/OFF** in the programmed Setpoint. The auto-tuning process may take several minutes to be completed, depending on the system. The steps for executing the PID auto-tuning are:

- Adjust the desired SP of the process. Select the process Setpoint.
- Enable auto-tuning at the parameter **Retun**, selecting **FAST** or **FULL**.

The option **FAST** performs the tuning in the minimum possible time, while the option **FULL** gives priority to accuracy over the speed.

During automatic tuning the indicator TUNE remains lit on the faceplate of the controller. The sign TUNE remains lit during the whole tuning phase. The user must wait for the tuning to be completed before using the controller.

During the execution of automatic tuning, PV oscillations can be introduced into the process around the setpoint.

During auto tuning period the controller will impose oscillations to the process. PV will oscillate around the programmed set point and controller output will switch on and off many times.

If the tuning does not result in a satisfactory control, refer to **Table 05** for guidelines on how to correct the behavior of the process.

PARAMETER	VERIFIED PROBLEM	SOLUTION
Band Proportional	Slow answer	Decrease
	Great oscillation	Increase
Rate Integration	Slow answer	Increase
	Great oscillation	Decrease
Derivative Time	Slow answer or instability	Decrease
	Great oscillation	Increase

Table 05 - Guidance for manual adjustment of the PID parameters

For further details on PID tuning, visit our web site: www.novusautomation.com.

SPECIFICATIONS

DIMENSION: 48 x 48 x 80 mm (1/16 DIN)
 Cutout in the panel: 45.5 x 45.5 mm (+0.5 -0.0 mm)
 Approximate weight: 75 g

POWER SUPPLY:

..... 100 to 240 Vac (50/60 Hz) / 48 to 240 Vdc $\pm 10\%$
 Optional 24 V: 12 to 24 Vdc / 24 Vac (-10 % / +20 %)
 Maximum consumption: 6 VA

ENVIRONMENTAL CONDITIONS:

Operation temperature: 0 to 50 °C
 Relative humidity: 80 % @ 30 °C
 For temperatures above 30 °C, reduce 3 % for each °C
 Internal use; Category of installation II, Degree of pollution 2;
 altitude < 2000 meters.

INPUT:

Accepted types: J, K, T and Pt100
 Internal resolution: 32767 levels (15 bits)
 Resolution of display: 0.1 / 1 (°C / °F)
 Rate of input reading: up 10 per second (*)
 Accuracy: Thermocouples **J, K, T**: 0.25 % of the *span* ± 1 °C
 Pt100: 0.2 % of the *span* ± 0.1 °C
 Input impedance: > 10 M Ω
 Measurement of Pt100: 3-wire type, ($\alpha=0.00385$)
 With compensation for cable length, excitation current of 0.170 mA.
 (*) Value adopted when the Digital Filter parameter is set to 0 (zero) value. For Digital Filter values other than 0, the Input Reading Rate value is 5 samples per second.

DIGITAL INPUT (DIG IN): dry contact / open collector NPN

OUT1: Voltage pulse, 5 V / 25 mA
OUT2: Relay SPST; 1.5 A / 240 Vac / 30 Vdc
OUT3: Relay SPST; 1.5 A / 240 Vac / 30 Vdc
OUT4: Relay SPDT; 3 A / 240 Vac / 30 Vdc

FRONT PANEL: IP65, Polycarbonate (PC) UL94 V-2

ENCLOSURE: IP30, ABS+PC UL94 V-0

SPECIFIC CONNECTIONS FOR TYPE FORK TERMINALS;

PROGRAMABLE CYCLE OF PWM: FROM 0.5 UP 100 SECONDS;
STARTS UP OPERATION: after 3 seconds connected to the power supply.

CERTIFICATION:  and  us.

IDENTIFICATION

N1040T-PRRR	Standard Model. Power supply 100~240 Vac / 48~240 Vdc
N1040T-PRRR-24V	Version with power supply 12~24 Vdc / 24 Vac

MAINTENANCE

PROBLEMS WITH THE CONTROLLER

Connection errors and inadequate programming are the most common errors found during the controller operation. A final revision may avoid loss of time and damages.







The controller displays some messages to help the user identify problems.

MESSAGE	DESCRIPTION OF THE PROBLEM
----	Open input. No sensor or signal.
Err 1 Err 6	Connection and/or configuration problems. Check the wiring and the configuration.

Other error messages may indicate hardware problems requiring maintenance service.

INPUT CALIBRATION

All inputs are factory calibrated and recalibration should only be done by qualified personnel. If you are not familiar with these procedures do not attempt to calibrate this instrument. In the case that it is necessary to recalibrate an input proceed as described in the following steps:

- a) Set the type parameter according to the input **TYPE**.
- b) Configure the lower and upper limits of indication for the maximum span of the selected input type.
- c) Access the calibration cycle.
- d) Enter the password.
- e) Enable the calibration setting YES in the parameter **CAL Ib**.
- f) Using a function generator, apply to the input terminals a signal level close to the lower limit of the configured input range.
With the aid of an electrical signals simulator, apply a signal level close the lower limit of the measuring range of the input, on the corresponding terminals.
- g) Access the parameter **InLc**. With the keys  and  adjust the display reading such as to match the applied signal. Then press the  key.
- h) Inject a signal that corresponds to a value a little lower than the upper limit of indication.
- i) Access the parameter **InHc**. With the keys  and , adjust the display reading such as to match the applied signal. Then press the key  until return to the Display PV screen.
- j) Validate the calibration performed.

Note: When checking the controller calibration with a Pt100 simulator, pay attention to the simulator minimum excitation current requirement, which may not be compatible with the 0.170 mA excitation current provided by the controller.

WARRANTY

Warranty conditions are available on our website www.novusautomation.com/warranty.