

Operating Instructions

Liquiphant FTL31 IO-Link

Point level switch for liquids

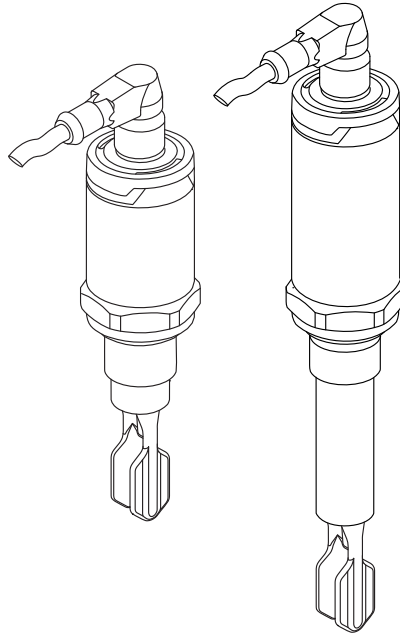

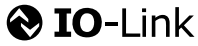
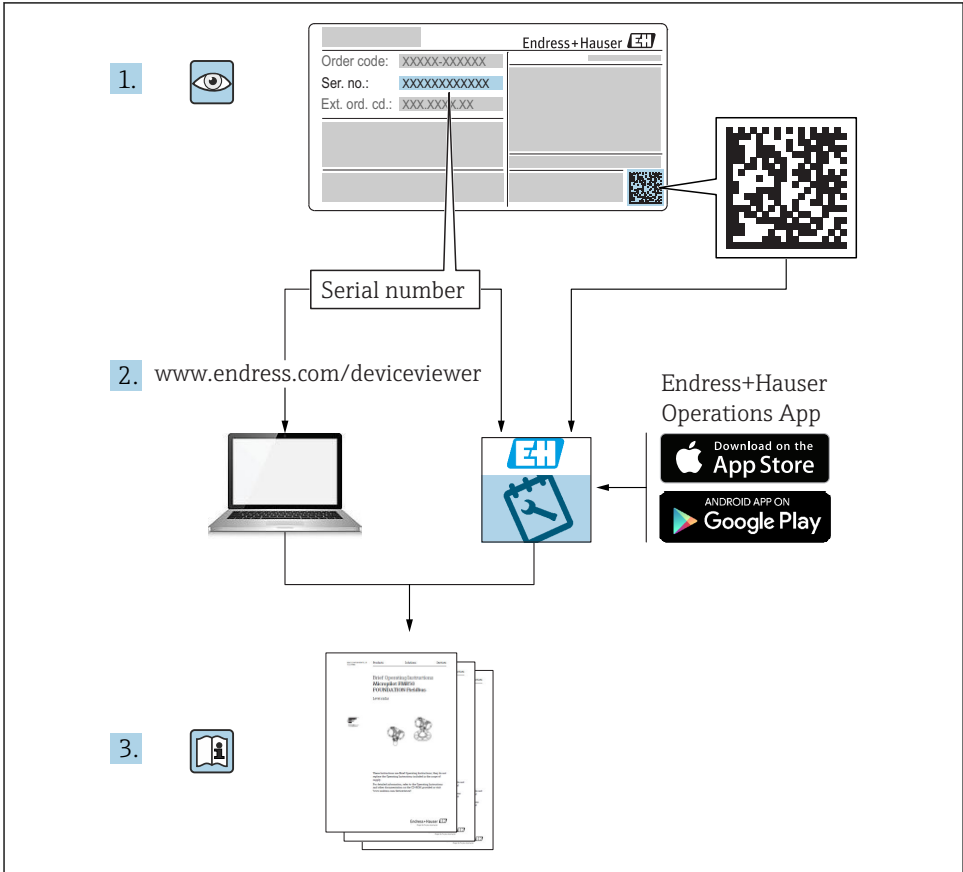

A0023555

Table of contents

1	About this document	4	10	Commissioning	30
1.1	Document function	4	10.1	Function check	30
1.2	Symbols used	4	10.2	Commissioning the local display	31
1.3	Documentation	6	10.3	Function test with test magnet	33
1.4	Registered trademarks	6	10.4	Commissioning with an operating menu	33
2	Basic safety instructions	7	11	Customer-specific IO-Link settings	34
2.1	Requirements for personnel	7	11.1	Configuring a customer-specific switch point with configuration of a switching delay and switchback delay:	34
2.2	Designated use	7			
2.3	Workplace safety	7			
2.4	Operational safety	8			
2.5	Product safety	8			
3	Product description	9	12	Diagnostics and troubleshooting	35
3.1	Product design	9	12.1	Troubleshooting	35
4	Incoming acceptance and product identification	10	12.2	Diagnostic information via LED indicator	35
4.1	Incoming acceptance	10	12.3	Diagnostic events	36
4.2	Product identification	10	12.4	Overview of diagnostic events	37
4.3	Manufacturer address	10	12.5	Behavior of the device in the event of a fault	37
4.4	Storage and transport	10	12.6	Resetting to factory settings (reset)	38
5	Installation	12	13	Maintenance	38
5.1	Installation conditions	12	13.1	Cleaning	38
5.2	Mounting the measuring device	18			
5.3	Post-installation check	19			
6	Electrical connection	20	14	Repair	39
6.1	Connection conditions	20	14.1	Return	39
6.2	Supply voltage	20	14.2	Disposal	39
6.3	Connecting the device	21			
6.4	Post-connection check	22	15	Description of device parameters	40
7	Operation options	23	15.1	Diagnosis	40
7.1	Operation with an operating menu	23	15.2	Parameters	43
			15.3	Observation	52
8	Overview of the operating menu	24	16	Accessories	52
9	System integration	26	17	Technical data	53
9.1	Process data	26	17.1	Power supply	53
9.2	Reading out and writing device data (ISDU – Indexed Service Data Unit)	26	17.2	Environment	53
			17.3	Process	55

1 About this document

1.1 Document function

These Operating Instructions contain all the information that is required in various phases of the life cycle of the device: from product identification, incoming acceptance and storage, to mounting, connection, operation and commissioning through to troubleshooting, maintenance and disposal.

1.2 Symbols used

1.2.1 Safety symbols

CAUTION

This symbol alerts you to a dangerous situation. Failure to avoid this situation can result in minor or medium injury.

DANGER

This symbol alerts you to a dangerous situation. Failure to avoid this situation will result in serious or fatal injury.

NOTICE

This symbol contains information on procedures and other facts which do not result in personal injury.





WARNING









This symbol alerts you to a dangerous situation. Failure to avoid this situation can result in serious or fatal injury.

1.2.2 Tool symbols



Symbol	Meaning
	Open-ended wrench

1.2.3 Symbols for certain types of information



Symbol	Meaning
	Permitted Procedures, processes or actions that are permitted.
	Preferred Procedures, processes or actions that are preferred.
	Forbidden Procedures, processes or actions that are forbidden.
	Tip Indicates additional information.

Symbol	Meaning
	Reference to documentation
	Reference to page
	Reference to graphic
	Notice or individual step to be observed
	Series of steps
	Result of a step
	Help in the event of a problem
	Visual inspection

1.2.4 Symbols in graphics

Symbol	Meaning
1, 2, 3 ...	Item numbers
	Series of steps
A, B, C, ...	Views
A-A, B-B, C-C, ...	Sections
	Hazardous area Indicates the hazardous area.
	Safe area (non-hazardous area) Indicates the non-hazardous area.

1.2.5 Symbols on the device

Symbol	Meaning
	Safety instructions Observe the safety instructions contained in the associated Operating Instructions.
	Connecting cable immunity to temperature change Specifies the minimum value of the temperature resistance of the connection cables.

1.3 Documentation

The following documentation types are available in the Downloads of the Endress+Hauser website (www.endress.com/downloads):



For an overview of the scope of the associated Technical Documentation, refer to the following:

- *W@M Device Viewer* (www.endress.com/deviceviewer): Enter the serial number from nameplate
- *Endress+Hauser Operations App*: Enter the serial number from the nameplate or scan the 2D matrix code (QR code) on the nameplate

1.3.1 Technical Information (TI): planning aid for your device

The document contains all the technical data on the device and provides an overview of the accessories and other products that can be ordered for the device.

1.3.2 Supplementary documentation

- **TI00426F**
Weld-in adapter, process adapter and flanges (overview)
- **SD01622P**
Installation instructions for weld-in adapter G 1", G ¾"
- **BA00361F**
Installation instructions for weld-in adapter M24x1.5

1.4 Registered trademarks

IO-Link

is a registered trademark of the IO-Link Consortium.

2 Basic safety instructions

2.1 Requirements for personnel

The personnel for installation, commissioning, diagnostics and maintenance must fulfill the following requirements:

- Trained, qualified specialists must have a relevant qualification for this specific function and task
- Are authorized by the plant owner/operator
- Are familiar with federal/national regulations
- Before beginning work, the specialist staff must have read and understood the instructions in the Operating Instructions and supplementary documentation as well as in the certificates (depending on the application)
- Following instructions and basic conditions

The operating personnel must fulfill the following requirements:

- Being instructed and authorized according to the requirements of the task by the facility's owner-operator
- Following the instructions in these Operating Instructions

2.2 Designated use

The measuring device described in this manual may be used only as a point level switch for liquids. Incorrect use may pose a hazard. To ensure that the measuring device remains in perfect condition during the operating time:

- Measuring devices must be used only for media to which the process-wetted materials have an adequate level of resistance.
- Comply with the limit values in the "Technical data" section.

2.2.1 Incorrect use

The manufacturer is not liable for damage caused by improper or non-designated use.

Residual risks

During operation heat from the process can cause the electronics housing, and the modules it contains, to reach temperatures of up to 80 °C (176 °F).

Danger of burns from contact with surfaces!

- ▶ In the event of elevated fluid temperatures, ensure protection against contact to prevent burns.

2.3 Workplace safety

For work on and with the device:

- ▶ Wear the required personal protective equipment according to federal/national regulations.
- ▶ Switch off the supply voltage before connecting the device.

2.4 Operational safety

Risk of injury!

- ▶ Operate the device in proper technical condition and fail-safe condition only.
- ▶ The operator is responsible for the interference-free operation of the device.

2.5 Product safety

This measuring device is designed in accordance with good engineering practice to meet state-of-the-art safety requirements, has been tested, and left the factory in a condition in which it is safe to operate. It meets general safety standards and legal requirements. It also complies with the EC directives listed in the device-specific EC Declaration of Conformity. Endress +Hauser confirms this by affixing the CE mark to the device.

3 Product description

The Liquiphant FTL31 is a point level switch for universal use in all liquids. It is used preferably in storage tanks, mixing vessels and pipes.

3.1 Product design

The point level switch is available in different versions, which can be assembled in accordance with user specifications.

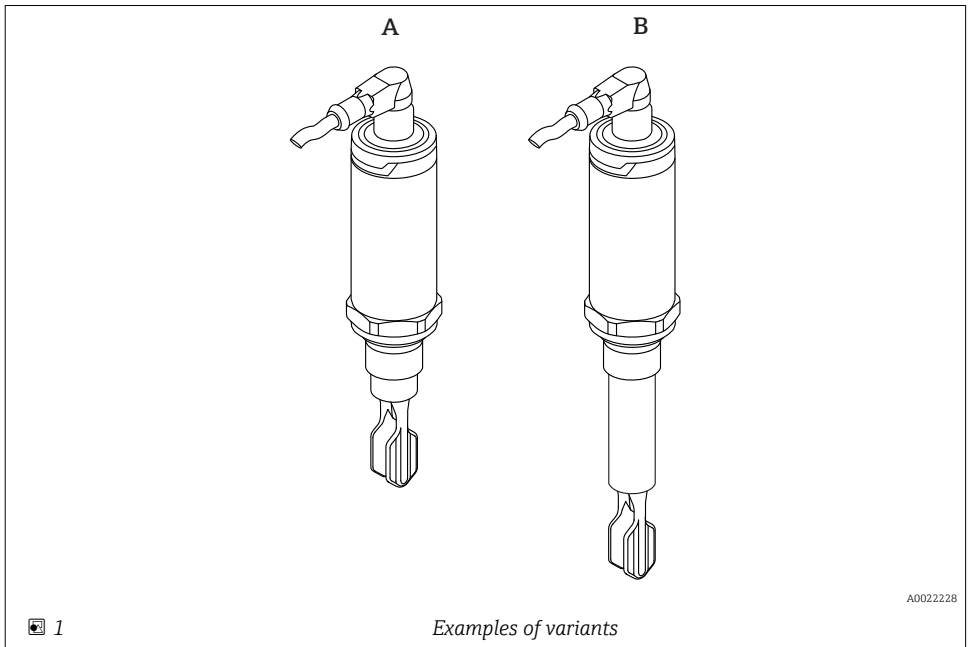

Versions	Examples	
	A	B
Electrical connection	M12 plug	M12 plug
Housing (sensor design) for process temperatures up to:	150 °C (302 °F)	150 °C (302 °F)
Sensor type	Compact version	Short tube version

 For detailed information on the short tube version and the process connections, see "Technical Information".

Available in Downloads area of the Endress+Hauser website (www.endress.com/downloads).

4 Incoming acceptance and product identification

4.1 Incoming acceptance

Check the following during incoming acceptance:

- Are the order codes on the delivery note and the product sticker identical?
- Are the goods undamaged?
- Do the nameplate data match the ordering information on the delivery note?
- If required (see nameplate): Are the safety instructions (XA) provided?



If one of these conditions is not met, please contact the manufacturer's sales office.

4.2 Product identification

The following options are available for the identification of the measuring device:

- Nameplate specifications
- Extended order code with breakdown of the device features on the delivery note
- ▶ Enter the serial number from the nameplates into *W@M Device Viewer* (www.endress.com/deviceviewer)
 - ↳ All the information about the measuring device and the scope of the associated Technical Documentation are displayed.
- ▶ Enter the serial number from the nameplate into the *Endress+Hauser Operations App* or use the *Endress+Hauser Operations App* to scan the 2-D matrix code (QR Code) provided on the nameplate
 - ↳ All the information about the measuring device and the scope of the associated Technical Documentation are displayed.

4.3 Manufacturer address

Endress+Hauser SE+Co. KG
Hauptstraße 1
79689 Maulburg, Germany

Address of the manufacturing plant: See nameplate.

4.4 Storage and transport

4.4.1 Storage conditions

- Permitted storage temperature: -40 to +85 °C (-40 to +185 °F)
- Use original packaging.

4.4.2 Transporting the product to the measuring point

Transport the device to the measuring point in the original packaging.

4.4.3 Handling of the device

NOTICE

Risk of injury! Housing or fork may become damaged or tear!

- ▶ Transport the device to the measuring point in its original packaging or by the housing.
- ▶ Do not hold the device by the fork!
- ▶ Do not use the device as a ladder or climbing aid!
- ▶ Do not bend the fork!
- ▶ Do not shorten or lengthen the fork!

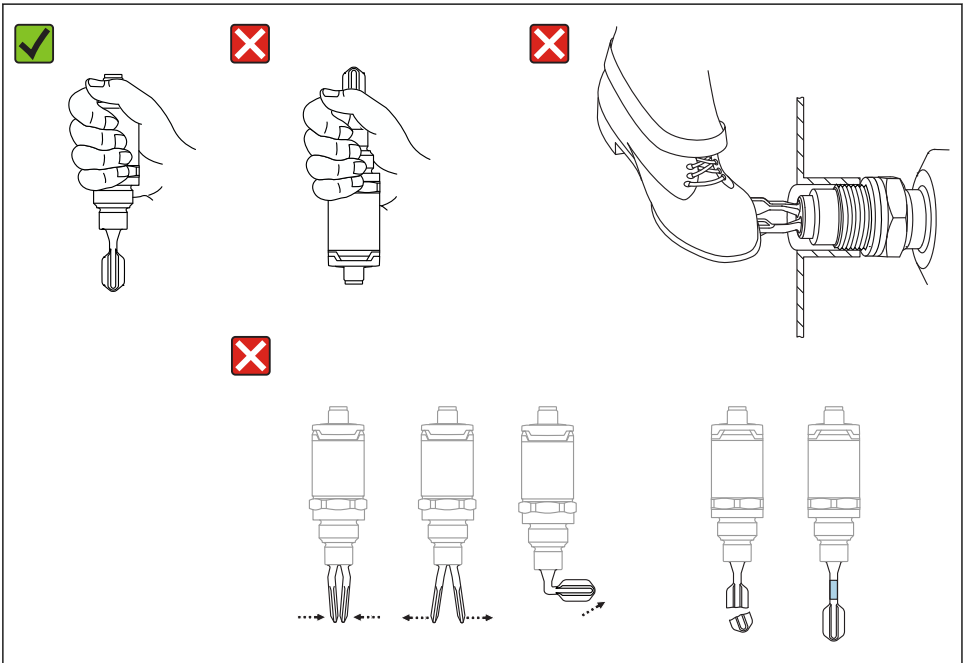

A0020845

2 Handling of the device

5 Installation

5.1 Installation conditions

5.1.1 Orientation

Installation is possible in any position in a vessel, pipe or tank.

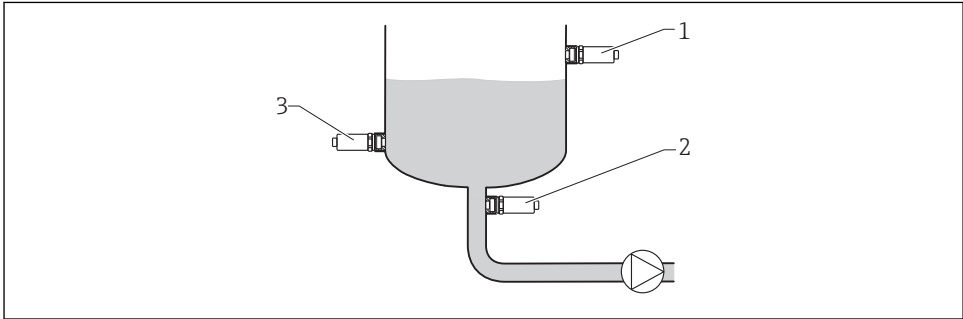

A0036961

3 Installation examples

- 1 *Overflow prevention or upper level detection (maximum safety)*
- 2 *Dry running protection for pump (minimum safety)*
- 3 *Lower level detection (minimum safety)*

5.1.2 Switch point

The switch point (A) on the sensor depends on the orientation of the point level switch (water +25 °C (+77 °F), 1 bar (14.5 psi)).

Configuration is possible via IO-Link.

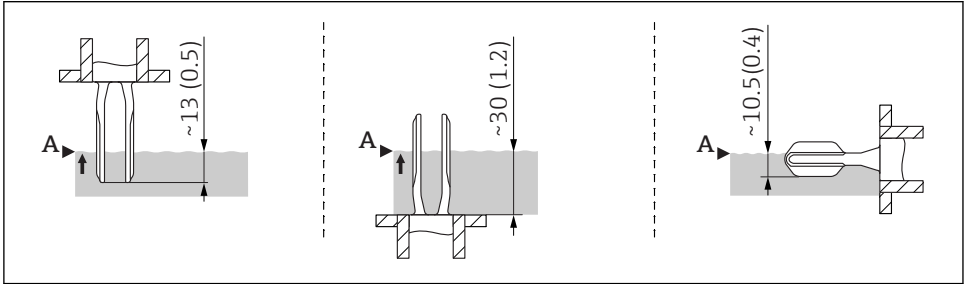

A0020734

4 Vertical and horizontal orientation, dimensions in mm (in)

5.1.3 Viscosity

Switching delays may occur in the case of highly viscous liquids. Make sure that the liquid can easily run off the tuning fork:

- If installing in vessels with high-viscosity liquids (A), the tuning fork may **not** be located in the installation socket!
- If installing in vessels with low-viscosity liquids (B), the tuning fork may be located in the installation socket!
- The installation nozzle must be no less than the minimum diameter of 50 mm (2.0 in).

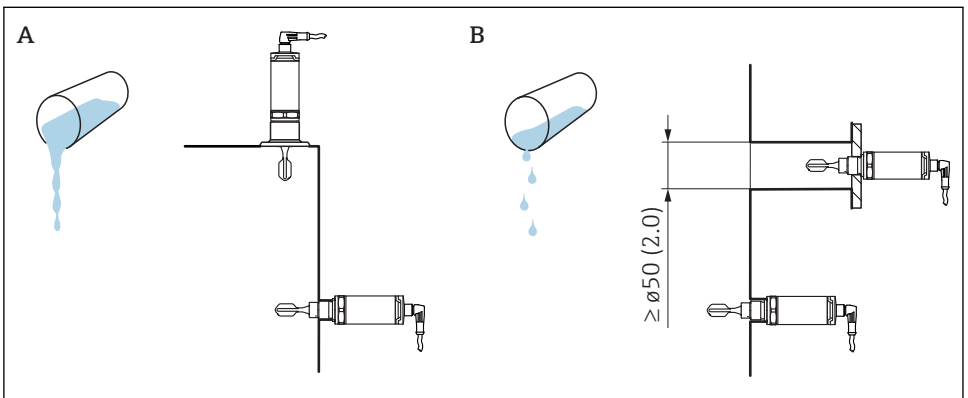

A0022054

5 Installation options with consideration given to the liquid viscosity, dimensions in mm (in)

A High viscosity (< 10 000 mPa·s)

B Low viscosity (< 2 000 mPa·s)

5.1.4 Buildup

Make sure that the installation socket does not exceed a certain length so that the tuning fork can project freely into the vessel.

Possibilities for optimization:

- A vertical orientation of the point level switch keeps buildup to a minimum.
- Preferably flush-mounted on vessels or in pipes.

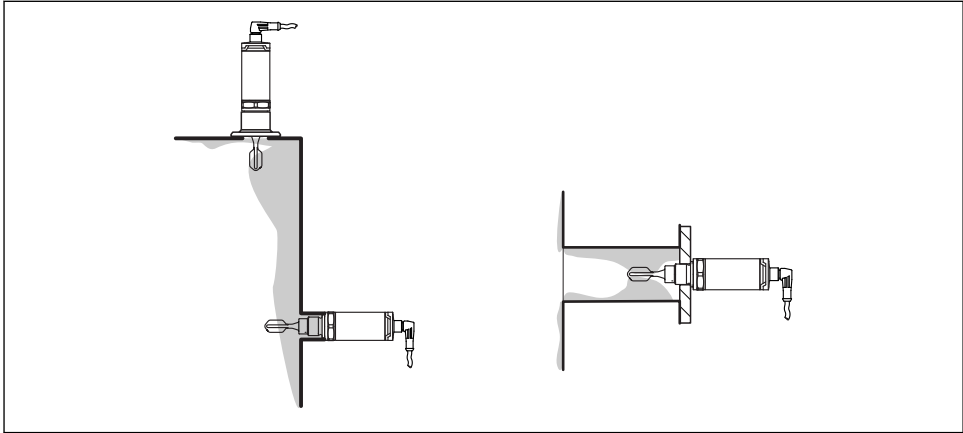

A0022057

6 *Buildup on tank wall, pipe wall and tuning fork*

5.1.5 Weld-in adapter with leakage hole

If installed horizontally, make sure that the leakage hole is pointing down. This allows leaks to be detected as quickly as possible.

5.1.6 Marking

The marking indicates the position of the tuning fork. If installed horizontally in vessels, the marking is face up.

The marking appears either as a material specification (e.g. 316L) or a thread designation (e.g. G 1/2") in the following locations:

- On the hexagonal bolt of the process adapter
- On the nameplate
- On the weld-in adapter

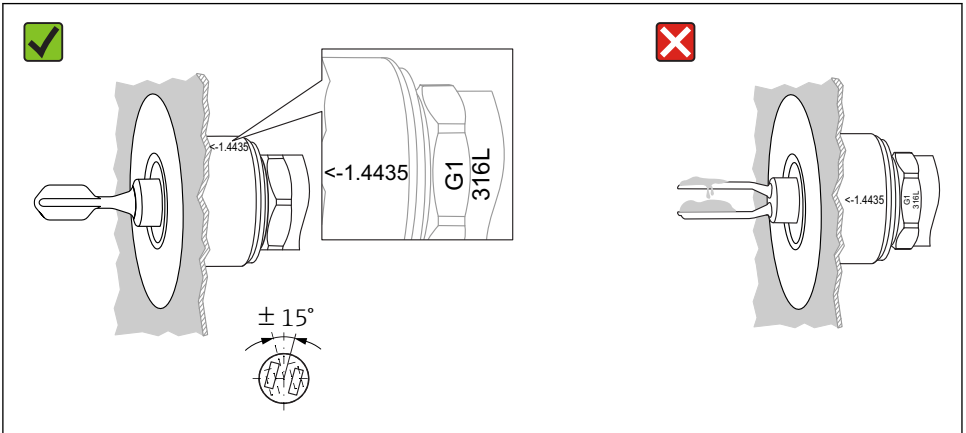

A0022641

7 Orientation in the vessel

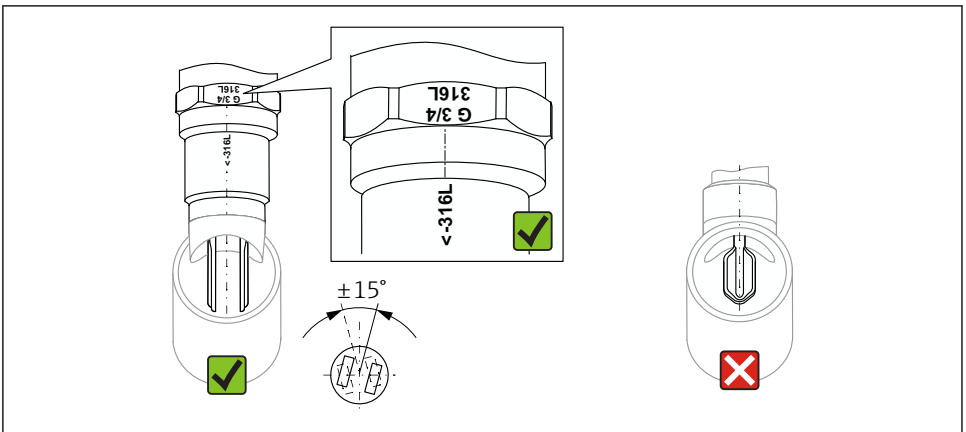

A0022804

8 Orientation in the pipe

5.1.7 Installation in pipes

During installation, pay attention to the position of the fork in order to minimize turbulence in the pipe.

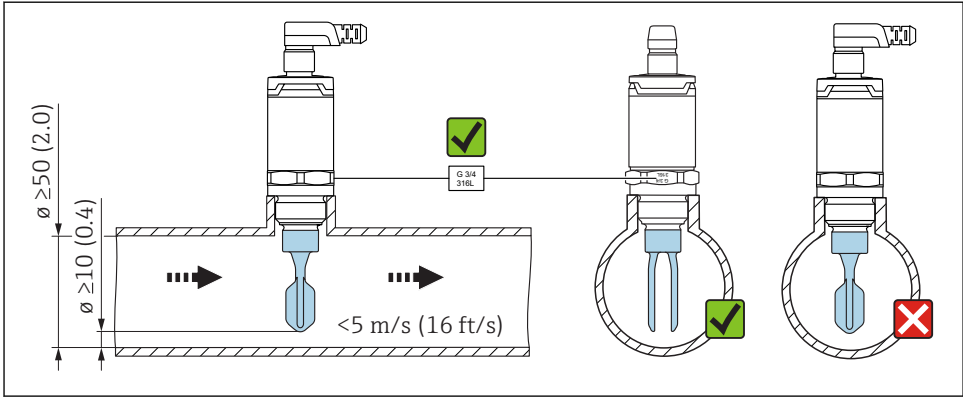

A0021357

Dimensions mm (in)

5.1.8 Installation in vessels

If installed horizontally, pay attention to the position of the tuning fork to ensure that the liquid can drip off.

The electrical connection, e.g. M12 connector, should be pointing down with the cable. This can prevent moisture from penetrating.

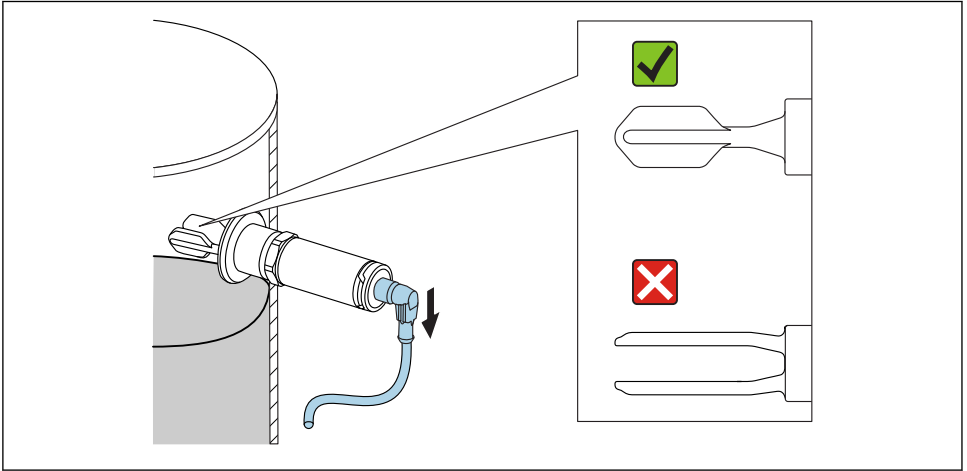

A0021034

9 Position of the fork in the case of horizontal installation in a vessel

5.1.9 Distance from wall

Ensure that there is sufficient distance between the expected buildup on the tank wall and the fork. Recommended distance from wall ≥ 10 mm (0.39 in).

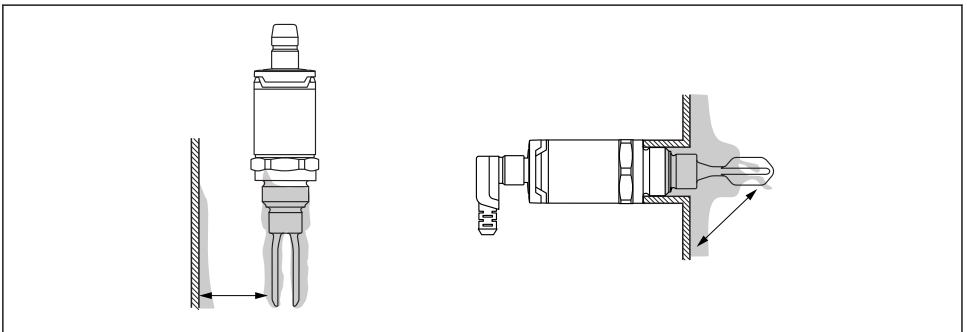

A0022272

5.2 Mounting the measuring device

i Use in accordance with WHG: Prior to mounting the device, pay attention to the WHG approval documents. Documents available in the Downloads area of the Endress+Hauser website: www.endress.com → Downloads

5.2.1 Required tools

"Weld-in adapter accessories" thread

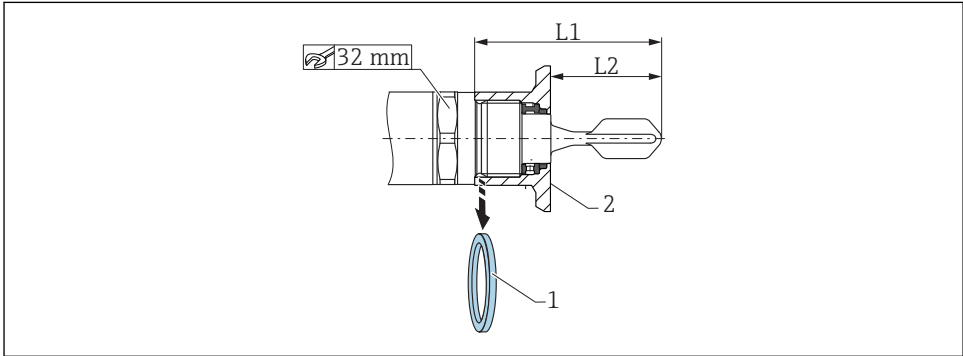

i 10 "Weld-in adapter accessories" thread

- 1 Flat seal
- 2 Weld-in adapter

G ¾"

- L1: 63.9 mm (2.52 in)
- L2: 38.0 mm (1.5 in)

G 1"

- L1: 66.4 mm (2.61 in)
- L2: 48.0 mm (1.89 in)

Pressure and temperature (maximum):

+25 bar (+362 psi) at +150 °C (+302 °F)

+40 bar (+580 psi) at +100 °C (+212 °F)

i When using a weld-in adapter with flush-mounted seal, the flat seal (1) supplied must be removed from the thread.

Metric thread in customer nozzle

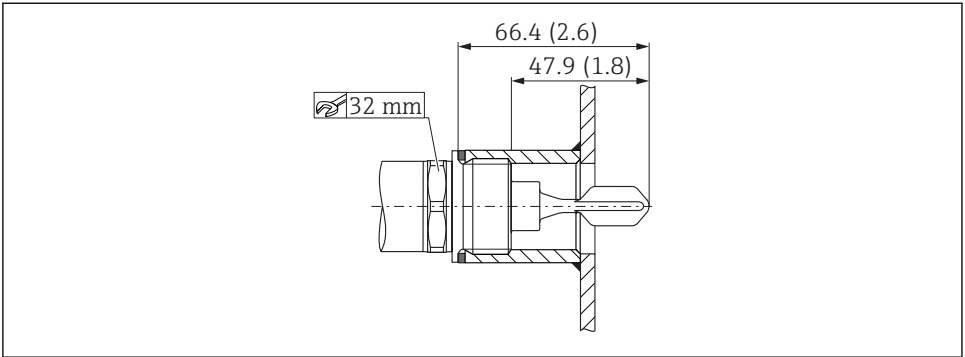

A0022026

 11 Metric thread in customer nozzle

G 1"

Pressure and temperature (maximum):

+40 bar (+580 psi) at 150 °C (302 °F)

NPT thread (ANSI B 1.20.1)

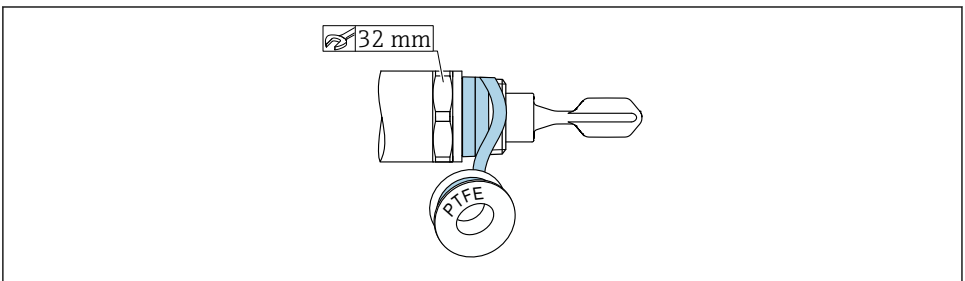

A0022028

 12 NPT thread (ANSI B 1.20.1)

Pressure and temperature (maximum):

+40 bar (+580 psi) at +150 °C (+302 °F)

 Wrap in sealing material if necessary.

5.3 Post-installation check

Are the device and cable undamaged (visual inspection)?

- Does the device comply with the measuring point specifications?
 - Process temperature
 - Process pressure
 - Ambient temperature range
 - Switch point/measuring range
- Are the measuring point identification and labeling correct (visual inspection)?
- Is the device adequately protected against moisture and direct sunlight?
- Is the device adequately protected against impact?
- Are all mounting and safety screws securely tightened?
- Is the device properly secured?

6 Electrical connection

6.1 Connection conditions

The measuring device has two modes of operation:

- **Maximum point level detection (MAX):** e. g. for overflow prevention
The device keeps the electrical switch closed as long as the sensor is not yet covered by liquid or the measured value is within the process window.
- **Minimum point level detection (MIN):** e. g. to protect pumps from dry running
The device keeps the electrical switch closed as long as the sensor is covered by liquid or the measured value is outside the process window.

Choosing the "MAX" / "MIN" mode of operation ensures that the device switches in a safety-oriented manner even in an alarm condition, e. g. if the power supply line is disconnected. The electronic switch opens if the point level is reached, if a fault occurs or if the power fails (quiescent current principle).



- IO-Link: Communication on pin 4; switch mode on pin 2.
- SIO mode: If there is no communication, the device switches to the SIO mode = standard IO mode.

The functions configured in the factory for the MAX and MIN modes can be changed via IO-Link:

- HNO/HNC hysteresis
- FNO/FNC window

6.2 Supply voltage

SIO mode

10 to 30 VDC

IO-Link mode

18 to 30 VDC

IO-Link communication is guaranteed only if the supply voltage is at least 18 V.

6.3 Connecting the device

⚠ WARNING

Risk of injury from the uncontrolled activation of processes!

- ▶ Switch off the supply voltage before connecting the device.
- ▶ Make sure that downstream processes are not started unintentionally.

⚠ WARNING

Electrical safety is compromised by an incorrect connection!

- ▶ In accordance with IEC/EN61010 a separate circuit breaker must be provided for the device .
- ▶ Voltage source: Non-hazardous contact voltage or Class 2 circuit (North America).
- ▶ The device must be operated with a 500 mA fine-wire fuse (slow-blow).
- ▶ Protective circuits against reverse polarity are integrated.

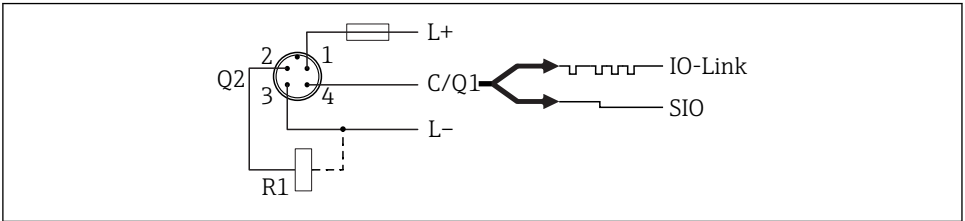

A0037916

- Pin 1 Supply voltage +
- Pin 2 1st switch output
- Pin 3 Supply voltage -
- Pin 4 IO-Link communication or 2nd switch output (SIO mode)

6.3.1 SIO mode (without IO-Link communication)

Minimum safety			
Terminal assignment	MIN output	LED yellow (ye) 1	

A0037919

Maximum safety		
Terminal assignment	MAX output	LED yellow (ye 2)

Function monitoring

When both outputs are connected, the MIN and MAX outputs assume opposite states (XOR) when the device is operating fault-free. In the event of an alarm condition or a cable break, both outputs are de-energized. This means that function monitoring is possible in addition to level monitoring. The behavior of the switch outputs can be configured via IO-Link.

Connection for function monitoring using XOR operation					
Terminal assignment	MAX output	LED yellow (ye 2)	MIN output	LED yellow (ye 1)	LED red (rd)

6.4 Post-connection check

- Are the device and cable undamaged (visual inspection)?
- Does the supply voltage match the specifications on the nameplate?
- If supply voltage is present, is the green LED lit?
- With IO-Link communication: is the green LED flashing?

7 Operation options

7.1 Operation with an operating menu

7.1.1 IO-Link information

IO-Link is a point-to-point connection for communication between the measuring device and an IO-Link master. The measuring device features an IO-Link communication interface type 2 with a second IO function on pin 4. This requires an IO-Link-compatible assembly (IO-Link master) for operation. The IO-Link communication interface enables direct access to the process and diagnostic data. It also provides the option of configuring the measuring device on the fly.

Physical properties of the IO-Link interface:

- IO-Link specification: version 1.1
- IO-Link Smart Sensor Profile 2nd Edition ¹⁾
- SIO mode: yes
- Speed: COM2; 38.4 kBaud
- Minimum cycle time: 6 msec.
- Process data width: 16 bit
- IO-Link data storage: yes
- Block parameterization: yes
- Device operational: The measuring device is operational 1 second after the supply voltage is applied.

7.1.2 IO-Link download

<http://www.endress.com/download>

- Select "Software" as the media type.
- Select "Device Driver" as the software type.
Select IO-Link (IODD).
- In the "Text Search" field enter the device name.

<https://ioddfinder.io-link.com/>

Search by

- Manufacturer
- Article number
- Product type

7.1.3 Structure of the operating menu

The menu structure has been implemented according to VDMA 24574-1 and complemented by Endress+Hauser-specific menu items.



For an overview of the operating menu, see the "Overview of the operating menu" section.

1) supports minimum scope of IdentClass

8 Overview of the operating menu

 Depending on the parameter configuration, not all submenus and parameters are available. Information on this can be found in the parameter description under "Prerequisite".

IO-Link	Level 1	Level 2
Identification	Serial number	Firmware version
		Extended Ordercode
		ProductName
		ProductText
		VendorName
		VendorText
		Hardware revision
		ENP_VERSION
		Application Specific Tag
		Device Type
		Diagnosis
Forkfrequency		
Simulation Switch Output 1 (OU1)		
Simulation Switch Output 2 (OU2)		
Device search		
Sensor check		
Parameter	Application	
		Reset user switchpoints
		Switch point value, Output 1 (SP1/FH1)
		Switchback point value, Output 1 (rP1/FL1)
		Switching delay time, Output 1 (dS1)
		Switchback delay time, Output 1 (dR1)
		Output 1 (OU1)
		Active switchpoints (OU2)
		Reset user switchpoints
		Switch point value, Output 2 (SP2/FH2)
		Switchback point value, Output 2 (rP2/FL2)

IO-Link	Level 1	Level 2
		Switching delay time, Output 2 (dS2)
		Switchback delay time, Output 2 (dR2)
		Output 2 (OU2)
	System	Operating hours
		µC-Temperature
		Unit changeover (UNI) - µC-Temperature
		Minimum µC-Temperature
		Maximum µC-Temperature
		Reset µC temperatures [button]
		Reset to factory settings
		DeviceAccessLocks.DataStorage
Observation	Forkfrequency	
	Switch State Output 1 (OU1)	
	Switch State Output 2 (OU2)	

9 System integration

9.1 Process data

The FTL3x devices can be configured with one or two switch outputs. The status of the switch output is transmitted in the form of process data via IO-Link.

- In the SIO mode, switch output 1 is switched at pin 4 of the M12 plug. In the IO-Link communication mode, this pin is reserved exclusively for communication.
- The device's process data are transmitted cyclically in 16-bit chunks.

Bit	0 (LSB)	1	...	12	13 (MSB)	14	15
Measuring device	Fork frequency [0 to 100.0 %], resolution 0.1 %					OU1	OU2

Bit 30 and bit 31 indicate the status of the switch outputs.

Here, 1 or DC 24 V corresponds to the logical "closed" state on the switch output.

The remaining 14 bits contain the value for the fork frequency [0 to 100.0 %]. A conversion is not necessary.

Bit	Process value	Value range
15	OU2	0 = open 1 = closed
14	OU1	0 = open 1 = closed
0...13	Raw value, not coverage [0 to 100]	Integer

The fork frequency is provided by the device as int13. The decimal separator must then still be determined using a gradient.

9.2 Reading out and writing device data (ISDU – Indexed Service Data Unit)

Device data are always exchanged acyclically and at the request of the IO-Link master. Using the device data, the following parameter values or device statuses can be read out:

9.2.1 Endress+Hauser-specific device data

Designation	ISDU (dec)	ISDU (hex)	Size (byte)	Data type	Access	Default value	Value range	Offset / Gradient	Data storage	Range limits
Extended Ordercode	259	0x0103	60	String	r/-					
ENP_VERSION	257	0x0101	16	String	r/-	02.03.00				
Device Type	256	0x0100	2	UInteger16	r/-	0x92FD				
Forkfrequency	79	0x004F	2	UInt16	r/-		0...1300	0 / 0.02	No	

Designation	ISDU (dec)	ISDU (hex)	Size (byte)	Data type	Access	Default value	Value range	Offset / Gradient	Data storage	Range limits
Simulation Switch Output 1 (OU1)	89	0x0059	1	UInt8	r/w	0~off	0 ~ off 1 ~ ou1 = high 2 ~ ou1 = low	0 / 0	No	0..2
Simulation Switch Output 2 (OU2)	68	0x0044	1	UInt8	r/w	0~off	0 ~ off 1 ~ ou1 = high 2 ~ ou1 = low	0 / 0	No	0..2
Device search	69	0x0045	1	UInt8	r/w	0~off	0 ~ off 1 ~ on	0 / 0	No	0..1
Sensor check	70	0x0046	1	UInt8	-/w			0 / 0	No	
Active switchpoints (OU1)	64	0x0040	1	UInt8	r/w	0 ~ Density >0.7g/cm ³ 1 ~ Density >0.5g/cm ³ 2 ~ User	0 ~ Density >0.7g/cm ³ 1 ~ Density >0.5g/cm ³ 2 ~ User			0..2
Reset user switchpoints	65	0x0041	1	UIntegerT	r/w	0 ~ False	0 ~ False 1 ~ switchpoints Ou1			0 to 1
Switch point value, Output 1 (SP1/FH1)	71	0x0047	2	UInt16	r/w	88.0		0 / 1	Yes	45...97
Switchback point value, output 1 (rP1/FL1)	72	0x0048	2	UInt16	r/w	91.0		0 / 1	Yes	45...97
Switching delay time, Output 1 (dS1)	81	0x0051	2	UInt16	r/w	0.5		0 / 0.1	Yes	0.3 to 60
Switchback delay time, Output 1 (dR1)	82	0x0052	2	UInt16	r/w	1		0 / 0.1	Yes	0.3 to 60
Output 1 (OU1)	85	0x0055	1	UInt8	r/w	0~HNO	0 ~ HNO 1 ~ HNC 2 ~ FNO 3 ~ FNC		Yes	0..3
Output 1 (OU1)	101	0x0065	1	UInt8	r/w	0~HNO	0 ~ HNO 1 ~ HNC		Yes	0..1

Designation	ISDU (dec)	ISDU (hex)	Size (byte)	Data type	Access	Default value	Value range	Offset / Gradient	Data storage	Range limits
Active switchpoints (OU2)	77	0x004D	1	UInt8	r/w	0 ~ Density >0.7g/cm ³ 1 ~ Density >0.7g/cm ³ 2 ~ User	0 ~ Density >0.7g/cm ³ 1 ~ Density >0.5g/cm ³ 2 ~ User			0..2
Reset user switchpoints	102	0x0066	1	UIntegerT	r/w	0~False	0 ~ False 1 ~ switchpoints Ou2			0 to 1
Switch point value, Output 2 (SP2/FH2)	75	0x004B	2	UInt16	r/w	88.0		0 / 1	Yes	45...97
Switchback point value, Output 2 (rP2/FL2)	76	0x004C	2	UInt16	r/w	91.0		0 / 1	Yes	45...97
Switching delay time, Output 2 (dS2)	83	0x0053		UInt16		0.5		0 / 0.1		0.3 to 60
Switchback delay time, Output 2 (dR2)	84	0x0054		UInt16		1		0 / 0.1		0.3 to 60
Output 2 (OU2)	86	0x0056	1	UInt8	r/w	0~HNC	0 ~ HNO 1 ~ HNC 2 ~ FNO 3 ~ FNC		Yes	0..3
Output 2 (OU2)	95	0x005F	1	UInt8	r/w	0~HNC	0 ~ HNO 1 ~ HNC		Yes	0..1
Operating hours	96	0x0060	4	UInt32	r/-	0		0 / 0.016667	No	0 to 2 ³²
µC-Temperature	91	0x005B	1	Int8	r/-			°C: 0 / 1 °F: 32 / 1.8 K: 273.15 / 1	No	-128..127
Unit changeover (UNI) - µC-Temperature	80	0x0050	1	UInt8	r/w	°C	0 ~ °C 1 ~ °F 2 ~ K	0 / 0	Yes	0..2

Designation	ISDU (dec)	ISDU (hex)	Size (byte)	Data type	Access	Default value	Value range	Offset / Gradient	Data storage	Range limits
Minimum μ C-Temperature	92	0x005C	1	Int16	r/-	127		$^{\circ}$ C: 0 / 1 $^{\circ}$ F: 32 / 1.8 K: 273.15 / 1	No	-32768 .. 32767
Maximum μ C-Temperature	93	0x005D	1	Int16	r/-	-128		$^{\circ}$ C: 0 / 1 $^{\circ}$ F: 32 / 1.8 K: 273.15 / 1	No	-32768 .. 32767
Reset μ C Temperatures [button]	94	0x005E	1	UIntegerT	-/w	0~False	0 ~ False 1 ~ Reset Temperature			0..1
Active switchpoints (OU1)	64	0x0040	1	UInt8	r/w	0 ~ Density >0.7g/cm ³ 1 ~ Density >0.5g/cm ³ 2 ~ User				0..2
Reset user switchpoints	65	0x0041	1	UIntegerT	r/w	0~False	0 ~ False 1 ~ switchpoints Ou1			0..1

9.2.2 IO-Link-specific device data

Designation	ISDU (dec)	ISDU (hex)	Size (byte)	Data type	Access	Default value	Data storage
Serial number	21	0x0015	max. 16	String	r/-		
Firmware version	23	0x0017	max. 64	String	r/-		
ProductID	19	0x0013	max. 64	String	r/-	FTL31 / FTL33	
ProductName	18	0x0012	max. 64	String	r/-	Liquiphant	
ProductText	20	0x0014	max. 64	String	r/-	Vibronic point level switch	
VendorName	16	0x0010	max. 64	String	r/-	Endress+Hauser	
VendorId	7 ... 8	0x0007 to 0x0008			r/-	17	
VendorText	17	0x0011	max. 64	String	r/-	People for Process Automation	
DeviceId	9 to 11	0x0009 to 0x000B			r/-	0x000400	
Hardware revision	22	0x0016	max. 64	String	r/-		

Designation	ISDU (dec)	ISDU (hex)	Size (byte)	Data type	Access	Default value	Data storage
Application Specific Tag	24	0x0018	32	String	r/w		
Actual Diagnostics (STA)	260	0x0104	4	String	r/-		
Last Diagnostic (LST)	261	0x0105	4	String	r/-		

9.2.3 System commands

Designation	ISDU (dec)	ISDU (hex)	Value range	Access
Reset to factory settings (RES)	2	0x0002	130	-/w
Device Access Locks.Data Storage Lock	12	0x000C	0 ~ False 2 ~ True	r/w

10 Commissioning

10.1 Function check

Prior to commissioning, make sure that the post-installation and post-connection checks have been performed.

See:

- "Post-installation check" checklist
- "Post-connection check" checklist



Function test: Immerse tuning fork in water

10.2 Commissioning the local display

10.2.1 Light signals (LEDs)

Position of LEDs in housing cover

Position	LED color	Description of function
1	green (gn)	Status/Communication <ul style="list-style-type: none"> ■ lit: SIO mode ■ flashing: Active communication, flash frequency ■ flashes with increased luminosity: Device search (device identification), flash frequency
2	red (rd)	Warning/Maintenance required flashing: Error remediable, e. g. invalid calibration Fault/device failure lit: see Diagnostics and troubleshooting
3	yellow (ye)2	Switch status/switch output 2 ¹⁾ With IO-Link communication following customer calibration: sensor is covered by medium.
4	yellow (ye)1	Switch status/switch output 1 With IO-Link communication following customer calibration: sensor is covered by medium.

1) Activated only if both switch outputs are active.

There is no external signaling via LEDs on the metal housing cover (IP69). A connecting cable with an M12 plug and LED indicator can be ordered as an accessory if necessary. See "Accessories".

10.2.2 Function of LEDs

Any configuration of the switch outputs is possible. The following table shows the behavior of the LEDs in the SIO mode:

LEDs on housing cover with M12 connector, IO-Link

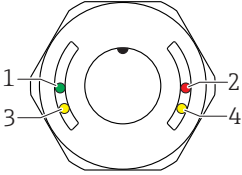
Operating modes	MAX		MIN		Warning	Fault
	free	covered	free	covered		
 <p style="text-align: right; font-size: small;">A0037920</p>						
1: green (gn)						
2: red (rd)						
3: yellow (ye) 2						
4: yellow (ye) 1						

LEDs on M12 connector (signals status of switch outputs)

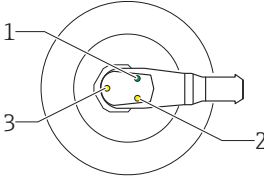
Operating modes	MAX		MIN		Warning	Fault
	free	covered	free	covered		
						
1: green (gn)					–	
2: yellow (ye)2					–	
3: yellow (ye)1					–	

10.3 Function test with test magnet

⚠ WARNING

Risk of injury!

- ▶ Ensure that no dangerous processes are triggered in the system.

To perform a function test, hold the test magnet against the marking on the nameplate (for at least 2 seconds). This inverts the current switching status and the yellow LED changes state. When the magnet is removed, the switching status valid at that time is adopted.

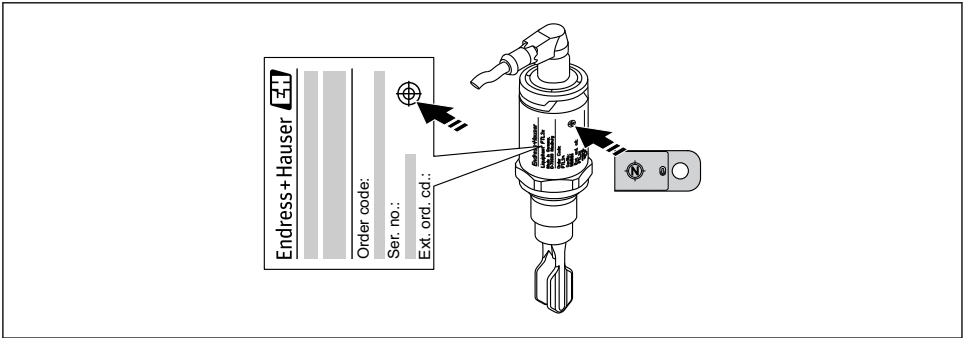

A0020960

13 Test magnet and marking

- i** The test magnet is not included in the scope of delivery and can be ordered as an optional accessory (see "Accessories" section).

10.4 Commissioning with an operating menu

If an existing configuration is changed, measuring operation continues! The new or modified entries are only accepted once the setting has been made.

Parameter changes are not accepted until after the parameters have been downloaded.



If using block configuration, parameter changes are accepted only after the parameters have been downloaded.

⚠ WARNING

Risk of injury and damage to property due to uncontrolled activation of processes!

- ▶ Make sure that downstream processes are not started unintentionally.

IO-Link communication

- Commissioning with factory settings: The device is configured for use with water-based media. The device can be commissioned directly when used with water-based media. Factory setting: output 1 and output 2 are configured for XOR operation.
 - Commissioning with customer-specific settings: The device can be configured differently to the factory settings via IO-Link. Select User in the **Active switchpoints** parameter.
-  ■ Each change must be confirmed with Enter to ensure that the value is accepted.
-  ■ Incorrect switching is suppressed by adjusting the settings in the switching delay / switchback delay (Switching delay time / Switchback delay time parameters).

11 Customer-specific IO-Link settings

11.1 Configuring a customer-specific switch point with configuration of a switching delay and switchback delay:

11.1.1 Switch point

1. Completely immerse sensor (tuning fork) in the medium.
2. Under "Process Data" --> "Forkfrequency", observe the oscillation frequency (as %). (Make a note of the value if necessary.)
3. Parameter --> Active switchpoints (OU1/OU2) --> "User"
4. Parameter --> Switch point value, Output 1/2 (SP1/2/FH1/2) and Switchback point value (rP1/2/FL1/2) to configure the switch point hysteresis.

11.1.2 Switching delay and switchback delay

1. Parameter --> Switching delay time, Out 1/2 (dS1/2), parameter for switching delay. Enter value in seconds.
2. Parameter --> Switchback delay time, Out 1/2 (dR1/2), enter parameter for switchback delay.

 All entries must be confirmed with Enter.

-  ■ **Block write mode:** All modified parameters are written into the device using the Download function.
- **Direct write mode:** After confirming a parameter with the Enter key, the parameter is written directly into the device

12 Diagnostics and troubleshooting

12.1 Troubleshooting

If an electronic/sensor defect is present, the device changes to the error mode and displays the diagnostic event F270. Diagnostic message issued via IO-Link as well as status LEDs on device.

The status of the process data is rendered invalid. The switch output(s) is/are opened.

General errors

Problem	Possible cause	Remedy
Device does not respond	Supply voltage does not match that specified on the nameplate.	Apply correct voltage.
	Supply voltage has incorrect polarity.	Reverse polarity of supply voltage.
	Connecting cables are not in contact with the terminals.	Check for electrical contact between cables and correct.
No communication	<ul style="list-style-type: none"> ■ Communication cable not connected. ■ Communication cable incorrectly attached to device. ■ Communication cable incorrectly attached to the IO-Link master. 	Check wiring and cables.

12.2 Diagnostic information via LED indicator

LED indicator on housing cover

Malfunction	Possible cause	Corrective action
Green LED not lit	No power supply	Check connector, cable and power supply.
Red LED flashing	Overload or short-circuit in load circuit	<ul style="list-style-type: none"> ■ Clear the short-circuit. ■ Reduce maximum load current to below 200 mA if one switch output is active. ■ Maximum load current = 105 mA per output if both switch outputs are active.
	Ambient temperature outside of specification	Operate measuring device in specified temperature range.
	Test magnet held against marking for too long	Repeat function test.
Red LED lit	Internal sensor error	Replace device.

LED indicator on M12 connector, can be ordered as an accessory

Malfunction	Possible cause	Corrective action
Green LED not lit	No power supply	Check connector, cable and power supply.

12.3 Diagnostic events

12.3.1 Diagnostic message

Faults that are detected by the device's self-monitoring system are displayed as a diagnostic message via IO-Link.

Status signals

The table lists the messages that may occur. The Actual Diagnostic (STA) parameter displays the message with the highest priority. The device has four different status information codes according to NE107:

F A0013956	"Failure" A device error has occurred. The measured value is no longer valid.
M A0013957	"Maintenance required" Maintenance is required. The measured value is still valid.
C A0013959	"Function check" The device is in the service mode (e. g. during a simulation).
S A0013958	"Out of specification" The device is being operated: <ul style="list-style-type: none"> ▪ Outside its technical specifications (e. g. during warmup or cleaning process) ▪ Outside the parameter configuration undertaken by the user (e. g. level outside of configured span)

Diagnostics event and event text

The fault can be identified by means of the diagnostic event.

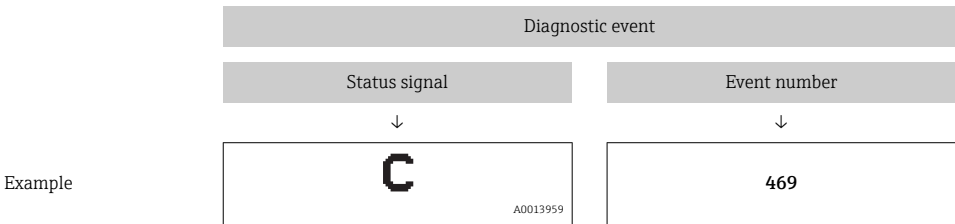

If two or more diagnostics events are pending simultaneously, only the message with the highest priority is shown.

 The last diagnostic message is displayed - see Last Diagnostic (LST) in the **Diagnosis** submenu.

12.4 Overview of diagnostic events

Status signal/ Diagnostic event	Diagnostic behavior	EventCode	Event text	Cause	Corrective measure
F270	IO-Link error	0x5000	Defect in electronics/ sensor	Defect in electronics/sensor	Replace device
S804	IO-Link warning	0x1801	Load current > I_{\max} per output Switch output defective	Overload at switch output 2	<ul style="list-style-type: none"> ▪ Increase load resistance at switch output ▪ Check output circuit ▪ Replace device
C485	IO-Link warning	0x8C01	During simulation of the switch output or current output, the device issues a warning message for the duration of the simulation.	Simulation active	Switch off simulation
C182	IO-Link message	0x1807	delta[%] too small during calibration	Invalid calibration	<ul style="list-style-type: none"> ▪ Verify probe coverage ▪ Carry out the adjustment again
C103	IO-Link message	0x1813	Sensor check failed	Sensor check failed	<ul style="list-style-type: none"> ▪ Clean again ▪ Replace device
	IO-Link message	0x1814		Sensor check passed	
	IO-Link information	0x1815		Timeout Reedcontact	Remove test magnet
S825	IO-Link warning	0x1812	Ambient temperature outside of specification	Ambient temperature outside of specification	Operate measuring device in specified temperature range
F042	IO-Link error	0x1816		Sensor corroded	Replace device

12.5 Behavior of the device in the event of a fault

The device displays warnings and faults via IO-Link. All the device warnings and faults are for information purposes only and do not have a safety function. The errors diagnosed by the device are displayed via IO-Link in accordance with NE107. In accordance with the diagnostic

message, the device behaves as per a warning or fault condition. It is necessary to distinguish between the following types of errors here:

- **Warning:**
 - The device continues measuring if this type of error occurs. The output signal is not affected (exception: simulation is active).
 - The switch output remains in the state defined by the switch points.
- **Fault:**
 - The device does **not** continue measuring if this type of error occurs. The output signal assumes its fault state (switch outputs de-energized).
 - The fault state is displayed via IO-Link.
 - The switch output changes to the "open" state.

12.6 Resetting to factory settings (reset)

See parameter description for Reset to factory settings (RES).

13 Maintenance

No special maintenance work is required.

13.1 Cleaning

The sensor must be cleaned if necessary. It can also be cleaned while installed (e.g. CIP Cleaning in Place / SIP Sterilization in Place). Care must be taken to ensure that no damage occurs to the sensor in the process.

14 Repair

Repair is not envisaged for the point level switch.

14.1 Return

The measuring device must be returned if it is in need of repair or a factory calibration, or if the wrong measuring device has been delivered or ordered. Legal specifications require Endress+Hauser, as an ISO-certified company, to follow certain procedures when handling products that are in contact with the medium.

Ensure that the device is returned quickly and in the correct manner. Information regarding the procedure and conditions is available on the Endress+Hauser website at www.services.endress.com/return-material.

14.2 Disposal

When disposing, separate and recycle the device components based on the materials.

15 Description of device parameters

15.1 Diagnosis

Actual Diagnostics (STA)

Navigation Diagnosis → Actual Diagnostics (STA)

Description Displays the current device status.

Last Diagnostic (LST)

Navigation Diagnosis → Last Diagnostic (LST)

Description Displays the latest device status (error or warning) that was rectified during operation.

Simulation switch Output 1 (OU1)

Navigation Diagnosis → Simulation switch Output 1 (OU1)

Description The simulation affects the process data only. It does not affect the physical switch output. If a simulation is active, a warning to this effect is displayed so that it is obvious to the user that the device is in the simulation mode. A warning is communicated via IO-Link (C485 - simulation active). The simulation must be ended actively via the menu. If the device is disconnected from the power supply during the simulation and power is then resupplied, the simulation mode is not resumed, and instead the device continues operation in the measuring mode.

Options ■ Off
 ■ OU1 = high
 ■ OU1 = low

Simulation switch Output 2 (OU2)

Navigation Diagnosis → Simulation Switch Output 2 (OU2)

Description The simulation affects the process data and the physical switch output. If a simulation is active, a warning to this effect is displayed via IO-Link so that it is obvious to the user that the device is in the simulation mode (C485 - simulation active). The simulation must be ended actively via the menu. If the device is disconnected from the power supply during the simulation and power is then resupplied, the simulation mode is not resumed, and instead the device continues operation in the measuring mode.

Options ■ Off
 ■ OU2 = high
 ■ OU2 = low

Device search

Navigation Diagnosis → Device search

Description This parameter is used to uniquely identify the device during installation.
 The green LED is lit (= operational) on the device and starts to flash with increased luminosity, flash frequency .

Note On the metal housing cover (IP69), there is no external signaling via LEDs.

Options ■ Off
 ■ On

 The function is deactivated after the device is restarted.

Factory setting Off

Sensor check

Navigation Diagnosis → Sensor check

Description

This parameter is used to test if the measuring point is functioning correctly.

The sensor must not be covered and must be free of residue. The device compares the current measured values with the measured values from the factory adjustment.

IO-Link message

Check: Following the test, one of the following messages is displayed:

- Message (0x1814) for sensor check passed
- Message C103 (0x1813) for sensor check failed

15.2 Parameters

15.2.1 Application

Active switchpoints

Navigation	Application → Active switchpoints
Description	Choose from standard (0.7 / 0.5 g/cm ³) or customer-specific, user-definable switch points
Switch-on value	Last setting selected prior to switching off device.
Options	<ul style="list-style-type: none"> ▪ Standard ▪ User
Factory setting	Standard

Reset user switchpoints

Navigation	Application → Reset user switchpoints
Note	This parameter is visible only if the User option is selected in the Active Switchpoint parameter.
Description	After selecting an output, switch point OU1 or OU2, the switch output and its associated value are reset to the factory setting.
Options	<ul style="list-style-type: none"> ▪ False ▪ switchpoints OU1 ▪ switchpoints OU2
Factory setting	False

**Switch point value (coverage), Output 1/2 (SP1/SP2), Output 1/2 (FL1/FL2)
Switchback point value (coverage), Output 1/2 (rP1/rP2), Output 1/2 (FH1/FH2)**

Navigation

Application → Switch point value, Output 1/2 (SP1/SP2)
Application → Switchback point value, Output 1/2 (rP1/rP2)

Note

The switching sensitivity of the sensor is set using the SP1/rP1 or SP2/rP2 parameters. Since the parameter settings depend on one another, the parameters are described all together.

- SP1 = switch point 1
- SP2 = switch point 2
- rP1 = switchback point 1
- rP2 = switchback point 2
- FL1 = lower value of window 1
- FL2 = lower value of window 2
- FH1 = upper value of window 1
- FH2 = upper value of window 2

Description

The switching sensitivity of the sensor can be configured using the switch point and switchback point. The switching sensitivity can be adapted to the medium (depending on the DC value (dielectric constant) or conductivity of medium).

- Sensor switches if there is slight coverage = very sensitive.
- Sensor switches if there is heavy buildup = not sensitive.

The set value for switch point SP1/SP2 must be less than switchback point rP1/rP2!

A diagnostic message is displayed if a switch point SP1/SP2 is entered that is \geq switchback point rP1/rP2.

When the set switchback point rP1/rP2 is reached, an electrical signal change takes place again at the switch output (OU1/OU2). The difference between the value of the switch point SP1/SP2 and the value of the switchback point rP1/rP2 is known as the hysteresis.

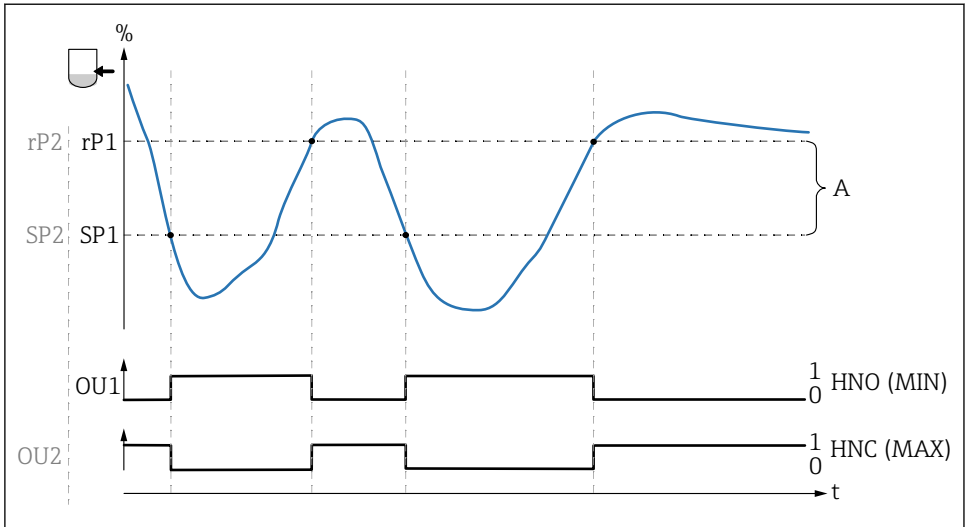

A0037934

0 0-signal, output open

1 1-signal, output closed

A Hysteresis (difference between the value of the switch point SP1/SP2 and the value of the switchback point rP1/rP2)

% Fork frequency (100 % corresponds to frequency in air / uncovered)

HNO Normally open contact (MIN)

HNC Normally closed contact (MAX)

SP1 Switch point 1 / SP2: Switch point 2

rP1 Switchback point 1 / rP2: Switchback point 2

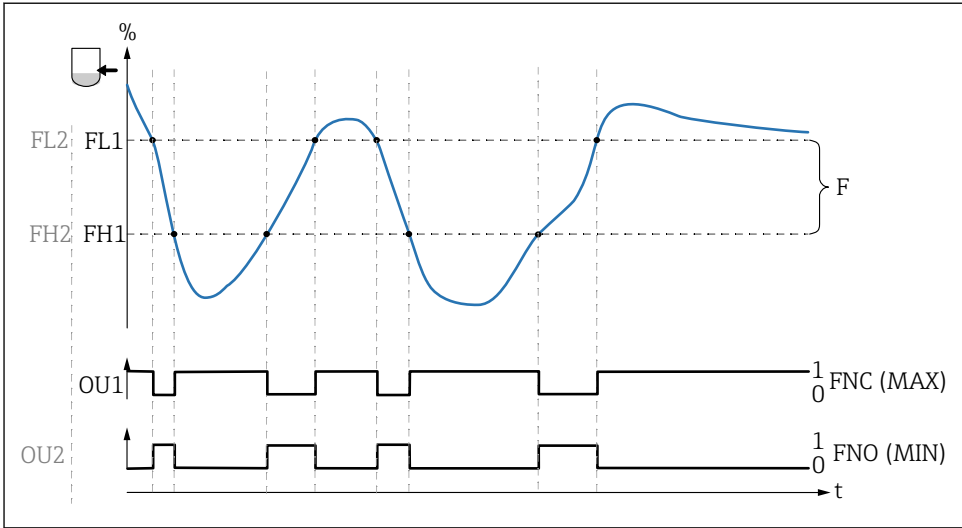

A0037950

0 0-signal, output open

1 1-signal, output closed

F Window

% Fork frequency (100 % corresponds to frequency in air / uncovered)

FNO Normally open contact (MIN)

FNC Normally closed contact (MAX)

FL1 Lower value of window

FH1 Upper value of window

Note The various points for the switching delay can be adjusted to ensure that rapid switching back and forth at the switch limits is suppressed.

Switch-on value Last value selected prior to switching off.

Options No selection. The user is free to edit the values.

Input range 45 to 97 %

Switching delay time, Output 1/2 (dS1/dS2)
Switchback delay time, Output 1/2 (dR1/dS2)

Navigation

Application → Switch output → Switching delay time,
Output 1/2 (dS1/dS2)
Application → Switch output → Switchback delay time,
Output 1/2 (dR1/dR2)

Note

The switching delay time/switchback delay time functions are implemented using the "dS1"/"dS2" and "dR1"/"dR2" parameters. Since the parameter settings depend on one another, the parameters are described all together.

- dS1 = switching delay time, output 1
- dS2 = switching delay time, output 2
- dR1 = switchback delay time, output 1
- dR2 = switchback delay time, output 2

Description

To prevent rapid switching back and forth when values are close to the switch point "SP1"/"SP2" or switchback point "rP1"/"rP2", a delay in the range of 0.3 to 60 seconds, to one decimal place, can be set for individual points.

If the measured value leaves the switching range during the delay time, the delay time starts again from scratch.

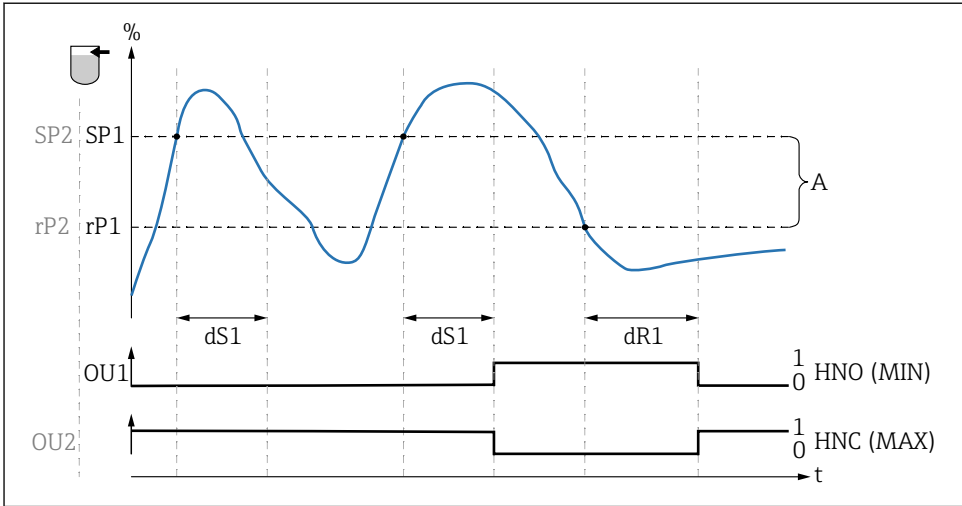

0 0-signal, output open in the quiescent state

1 1-signal, output closed in the quiescent state

A Hysteresis (difference between the value of the switch point "SP1" and the value of the switchback point "rP1")

HNO Normally open contact (MIN)

HNC Normally closed contact (MAX)

% Coverage of sensor

SP1 Switch point 1 / SP2: Switch point 2

rP1 Switchback point 1 / rP2: Switchback point 2

dS1 Set time for which the specific switch point must be reached continuously without interruption until an electrical signal change takes place.

dR1 Set time for which the specific switchback point must be reached continuously without interruption until an electrical signal change takes place.

Switch on value Last value selected prior to switching off.

Options No selection. The user is free to edit the values.

Input range 3 to 600

Factory setting 0.5 s (Switching delay time dS1/dS2)
1.0 s (Switchback delay time dR1/dR2)

Output 1/2 (OU1/OU2)

Navigation Application → Output 1/2 (OU1/OU2)

Description	<ul style="list-style-type: none"> ▪ Hysteresis: Determining whether sensor is free or covered. ▪ Window: Determining medium <ul style="list-style-type: none"> – SP1/rP1 = medium 1 – SP2/rP2 = medium 2
--------------------	--

Switch on value	Last function selected prior to switching off.
------------------------	--

Options	<ul style="list-style-type: none"> ▪ Hysteresis normally open (MIN) ▪ Hysteresis normally closed (MAX) ▪ Window normally open ▪ Window normally closed
----------------	--

Factory setting	Output 1 (OU1): HNO Output 2 (OU2): HNC
------------------------	--

15.2.2 System

Operating hours

Navigation	System → Operating hours
-------------------	--------------------------

Description	This parameter counts the operating hours in minutes during the period in which operating voltage is present.
--------------------	---

µC-Temperature

Navigation	System → µC temperature
-------------------	-------------------------

Description	This parameter displays the current µC-temperature on the electronics.
--------------------	--

Unit changeover (UNI) - µC-Temperature

Navigation	System → Unit changeover (UNI) - µC-Temperature
-------------------	---

Description	This parameter is used to select the electronics temperature unit. Once a new electronics temperature unit has been selected, the new unit is calculated and displayed.
Switch on value	Last unit selected prior to switching off.
Options	<ul style="list-style-type: none"> ■ °C ■ °F ■ K
Factory setting	°C

Minimum μ C-Temperature

Navigation	System → Minimum μ C temperature
Description	<p>This parameter is used as the minimum peak indicator and makes it possible to call up retroactively the lowest electronics temperature measured.</p> <p>If the value of the peak indicator is overwritten, the value is automatically set to the temperature currently measured.</p>

Maximum μ C temperature

Navigation	System → Maximum μ C temperature
Description	<p>This parameter is used as the maximum peak indicator and makes it possible to call up retroactively the highest electronics temperature measured.</p> <p>If the value of the peak indicator is overwritten, the value is automatically set to the temperature currently measured.</p>

Reset μ C-Temperature

Navigation	System → Reset μ C-Temperature
Description	This parameter ?

Reset to factory settings (RES)

Navigation

System → Reset to factory settings (RES)

Description



Confirming the "Standard Command" with "Reset to factory settings" causes an immediate reset to the factory settings of the order configuration.

If the factory settings have been changed, downstream processes might be affected following a reset (the behavior of the switch output or current output might be changed).

- ▶ Make sure that downstream processes are not started unintentionally.

The reset is not subject to additional locking, such as in the form of device locking. The reset also depends on the device status.

Any customer-specific configuration carried out at the factory is not affected by a reset (customer-specific configuration remains).

Note

The last error is not reset in a reset.

Device Access Locks.Data Storage Lock¹⁾ Activation/deactivation of DataStorage

- 1) The "Device Access Locks.Data Storage Lock" parameter is an IO-Link standard parameter. The name of the parameter may exist in the configured language in the IO-Link operating tool used. The display depends on the operating tool in question.

Navigation

System → Device Access Locks.Data Storage Lock

Description

The device supports DataStorage. If a device is being replaced, this allows the configuration of the old device to be written to the new device. If, when a device is being replaced, the original configuration of the new device is to be retained, the **Device Access Locks.Data Storage Lock** parameter can be used to prevent the parameters from being overwritten. If this parameter is set to "true", the new device does not adopt the data stored in the master's DataStorage.

Options

- false
- true

15.3 Observation

The process data are transmitted acyclically.

16 Accessories



For detailed information on accessories, see "Technical Information" for weld-in adapters, process adapters and flanges

Available in Downloads area of the Endress+Hauser website
(www.endress.com/downloads).

Designation	Additional information
Weld-in adapter	 For detailed information on weld-in adapters, see supplementary documentation. Available in Downloads area of the Endress+Hauser website (www.endress.com/downloads).
Seals, o-rings	
Plug-in jack M12 with cable 5 m (16 ft)	IP67, coupling nut (Cu Sn/Ni) <ul style="list-style-type: none"> ▪ Straight, order number: 52006263 ▪ Elbowed 90°, order number: 52010285
Socket wrench for mounting	Hexagon bolt, AF32, order number: 52010156
Test magnet	Order number: 71267011

17 Technical data



For additional technical data, see "Technical Information".

Available in Downloads area of the Endress+Hauser website (www.endress.com/downloads).

17.1 Power supply

Electronic version	Supply voltage	Power consumption
SIO mode, DC-PNP	10 to 30 V DC	< 975 mW
IO-Link	18 to 30 VDC	< 975 mW

17.2 Environment

Ambient temperature range	-40 to +70 °C (-40 to +158 °F), see derating
Storage temperature	-40 to +85 °C (-40 to +185 °F)
Climate class	DIN EN 60068-2-38/IEC 68-2-38: Test Z/AD
Altitude	Up to 2 000 m (6 600 ft) above sea level
Shock resistance	a = 300 m/s ² = 30 g, 3 planes x 2 directions x 3 shocks x 18 ms, as per test Ea, prEN 60068-2-27:2007
Vibration resistance	a(RMS) = 50 m/s ² , ASD = 1.25 (m/s ²) ² /Hz, f = 5 to 2000 Hz, t = 3 x 2 h, as per as per test Fh, EN 60068-2-64:2008
Reverse polarity protection	DC-PNP Integrated. In the event of reverse polarity, the device is deactivated automatically.
Short-circuit protection	DC-PNP Overload protection/short-circuit protection at I > 250 mA; the sensor is not destroyed. Intelligent monitoring: Testing for overload at intervals of approx. 1.5 s; normal operation resumes once the overload/short-circuit has been rectified.
Degree of protection	<ul style="list-style-type: none"> ▪ IP65/67 NEMA Type 4X Enclosure (M12 connector) ▪ IP65 NEMA Type 4X Enclosure (valve plug) ▪ IP66/68 NEMA Type 4X/6P Enclosure (cable)
Electromagnetic compatibility	Electromagnetic compatibility in accordance with all the relevant requirements of the EN 61326 series. For details, refer to the EC Declaration of Conformity. Available in the Download Area of the Endress+Hauser website: www.endress.com .

17.2.1 Derating

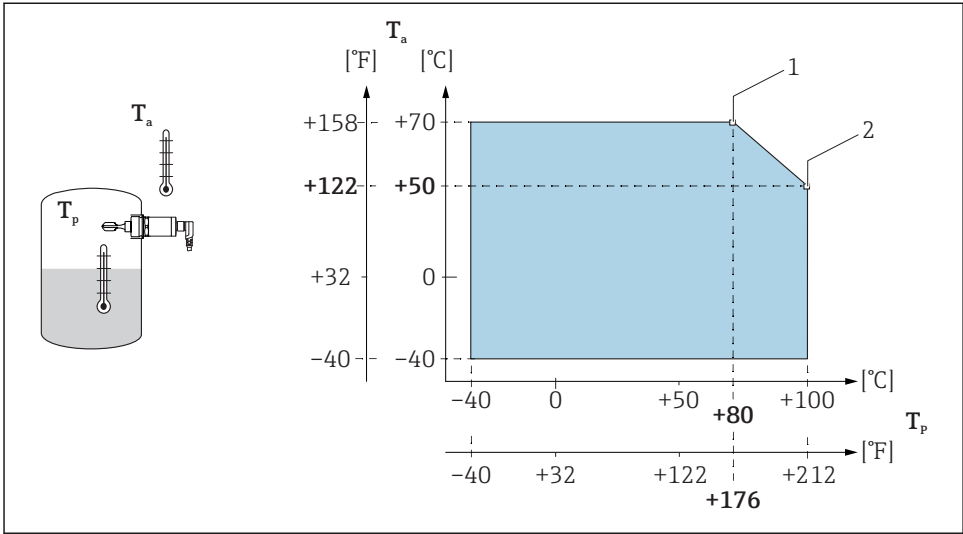

A0022002

14 Derating curve: 100°C (212°F)

1 I_{max} : 200 mA (DC-PNP), 250 mA (AC/DC)

2 I_{max} : 150 mA (DC-PNP), 150 mA (AC/DC)

T_a Ambient temperature range

T_p Process temperature

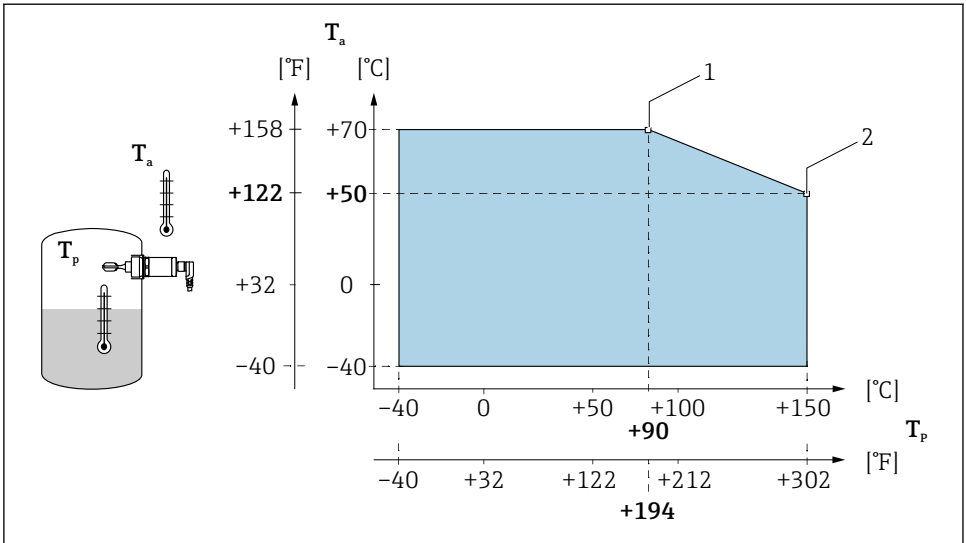

A0020869

15 Derating curve: 150 °C (302 °F)

1 I_{max} : 200 mA (DC-PNP), 250 mA (AC/DC)

2 I_{max} : 150 mA (DC-PNP), 150 mA (AC/DC)

T_a Ambient temperature range

T_p Process temperature

17.3 Process

NOTICE

► Note the pressure and temperature derating depending on the process connection selected.

Process temperature range	-40 to +100 °C (-40 to +212 °F) -40 to +150 °C (-40 to +302 °F)
Process pressure range	Max. -1 to +40 bar (-14.5 to +580 psi)
Density	> 0.7 g/cm ³ (optionally available: > 0.5 g/cm ³)
State of aggregation	Liquid
Viscosity	1 to 10,000 mPa · s dynamic viscosity
Solids contents	$\varnothing < 5$ mm (0.2 in)
Lateral loading capacity	Lateral loading capacity of the tuning fork: max. 200 N



71426391

www.addresses.endress.com
