

Technical Information

Nivector FTI26

Capacitive



Point level switch for powdered and fine-grained solids

Application

Reliable minimum or maximum detection of powders or fine-grained bulk solids in silos.

- Typical application examples: plastic granules, detergent, grain, sugar, spices, milk powder, animal feed
- Easy installation thanks to compact design - even in tight conditions or where access is restricted.
- Also suitable for use in
 - Food industry
 - Hazardous atmospheres formed by combustible dust, zone 20
 - Process temperatures of -20 to $+80$ °C (-4 to $+176$ °F).

Your benefits

- Onsite function check via LED indication
- Robust stainless steel housing, optionally available with M12x1 connector with IP69 protection
- Easy and cost-effective commissioning: Precalibration in factory (plug and play)
- Hygienic design, 3-A and EHEDG certificates
- Meets the requirements of EU 1935/2004
- FDA-compliant
- DC-PNP Output and IO-Link communication





Table of contents

About this document	3	Materials	14
Document conventions	3	Surface roughness	15
Function and system design	4	Operability	15
Measuring principle	4	Operating concept for devices with IO-Link	15
Measuring system	4	IO-Link information	15
Input	5	IO-Link download	15
Measured variable	5	Light signals (LEDs)	16
Measuring range	5	Device search	16
Output	5	Sensor check	16
Switch output	5	Medium calibration	16
Power supply	6	Function test	16
Supply voltage	6	Certificates and approvals	17
Power consumption	6	CE mark	17
Current consumption	6	C-tick symbol	17
Electrical connection	6	RoHS	17
Cable specification	8	RCM-Tick marking	17
Length of connecting cable	8	EAC conformity	17
Overvoltage protection	8	Pressure equipment with allowable pressure ≤ 200 bar (2 900 psi)	17
Performance characteristics	8	Ex approval	18
Reference operating conditions	8	Sanitary compatibility	18
Switch-on behavior	8	Manufacturer's Declaration	18
Influence of ambient temperature	8	Ordering information	18
Switch-on delay	8	Accessories	19
Switching delay	8	Adapter	19
Installation	9	Protector G 1½", R 1½"	19
Mounting location	9	Lock nut	19
Installation instructions	9	Protection cover	20
Environment	11	Test magnet	20
Ambient temperature range	11	Plug-in jack, connection adapter	20
Storage temperature	11	Supplementary documentation	21
Relative humidity	11	Operating Instructions	21
Climate class	11	Supplementary documentation	21
Altitude	11	Certificates	21
Degree of protection	11	Registered trademarks	21
Shock resistance	11		
Vibration resistance	11		
Cleaning	11		
Electromagnetic compatibility	11		
Reverse polarity protection	11		
Short-circuit protection	12		
Process	12		
Process temperature range	12		
Process pressure range	12		
Process fluid	12		
Mechanical construction	13		
Connector	14		
Weight	14		

About this document

Document conventions

Symbols for certain types of information

Symbol	Meaning
	Permitted Indicates procedures, processes or actions that are allowed.
	Preferred Indicates procedures, processes or actions that are preferred.
	Tip Indicates additional information.
	Reference to page Refers to the corresponding page number.

Symbols in graphics

Symbol	Meaning
1, 2, 3 ...	Item numbers
A, B, C, ...	Views

Function and system design

Measuring principle

The sensor surface of the Nivector evaluates the different dielectric values of air and bulk solids. If the bulk solids come into contact with the sensor surface, the electronics change the switch status. The Nivector can be switched to either minimum or maximum fail-safe mode, ensuring quiescent current operation in all applications. The switch status is indicated by an LED. A guard electrode eliminates interference factors due to the vessel wall or possible buildup, for example.

Depending on the fail-safe mode selected and the level, the Nivector switches and signals in the following cases:

- When point level is reached
- In the event of a problem
- In the event of a power failure (electrical switch is locked)

Measuring system

The measuring system comprises a Nivector point level switch, e. g. for connecting to PLCs or an IO-Link master as per DIN EN 61131-9. A suitable miniature contactor or a solenoid valve can be connected directly to the point level switch.

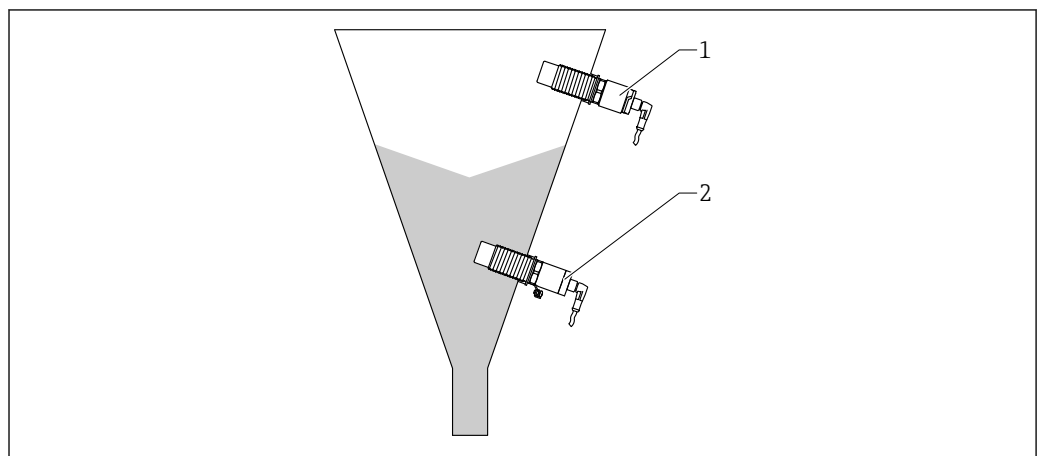

A0035880

1 Application examples

- 1 Overfill protection or upper level detection (MAX)
- 2 Dry-running protection or lower level detection (MIN)

System integration

For devices with IO-Link, an IO-DD is available in the Downloads area of the Endress+Hauser website → [15](#).

Input

Measured variable	Level (point level switch) The change in medium capacitance is detected by the electrode in contact with the process.
Measuring range	Bulk solids, e. g. foodstuffs in powder form <ul style="list-style-type: none"> ▪ Dielectric constant (Dk) > 1.3 ▪ Grain size < 10 mm

Output

Switch output	Designation	Option ¹⁾
	<ul style="list-style-type: none"> ▪ 3-wire DC-PNP Positive voltage signal at the switch output of the electronics ▪ 2 DC-PNP outputs, switched using XOR operation ▪ 200 mA connectable load (short-circuit proof) 	4
	Devices with IO-Link <ul style="list-style-type: none"> ▪ 3- or 4-wire DC-PNP ▪ 2 DC-PNP outputs, freely configurable ▪ 1 switch output active: 200 mA ²⁾ connectable load (short-circuit proof) ▪ Both switch outputs active: Connectable load of 105 mA each (short-circuit proof) 	7

1) Product Configurator, order code for "Power supply; output"





2) Unlike the IO-Link standard, the SIO mode supports 200 mA.

- Safety-related switching: MIN or MAX point level. The electrical switch opens if the point level is reached or if faults or a power outage occur.
 - Maximum point level detection (MAX): e. g. for overfill protection
The device keeps the electrical switch closed as long as the sensor is not yet covered by medium. This is also the case for devices with IO-Link if the measured value is inside the process window.
 - Minimum point level detection (MIN): e. g. for dry-running protection
The device keeps the electrical switch closed as long as the sensor is covered by medium. This is also the case for devices with IO-Link if the measured value is outside the process window.
- Residual voltage: < 3 V
- Residual current: < 100 µA

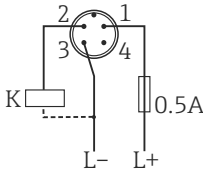
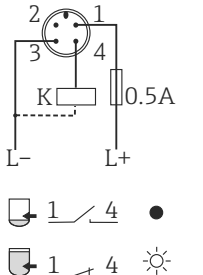
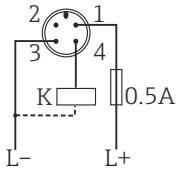
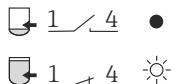

Power supply

Supply voltage	12 to 30 V DC IO-Link communication is guaranteed only if the supply voltage is at least 18 V.
Power consumption	< 1.2 W (at max. load:200 mA)
Current consumption	< 20 mA
Electrical connection	Voltage source: Non-hazardous contact voltage or Class 2 circuit (North America). The device must be operated with a fine-wire fuse 500 mA (slow-blow). Depending on the evaluation of the switch outputs, the device works in the MAX (maximum point level detection) or MIN (minimum point level detection) modes.

M12 plug

Electrical connection	Mode of operation	
M12 plug 	MAX  	MIN  
Symbols	Description	
	Yellow LED (ye) lit	
	Yellow LED (ye) not lit	
	External load	

Devices with IO-Link

-  IO-Link: Communication on C/Q1; switch mode on Q2.
-  SIO mode: If there is no communication, the device switches to the SIO mode = standard IO mode.

The factory-set functions for the MAX and MIN modes can be changed via IO-Link.

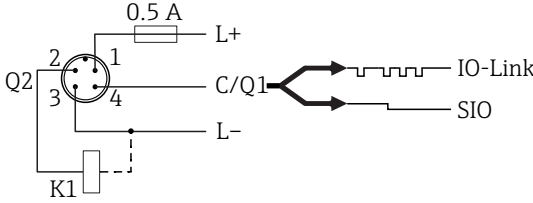
Electrical connection	IO-Link with one switch output ¹⁾
M12 plug 	 1 Supply voltage + 2 DC-PNP (Q2) 3 Supply voltage - 4 C/Q1 (IO-Link communication or SIO mode)

1) Product Configurator, order code for "Power supply; output", option 7

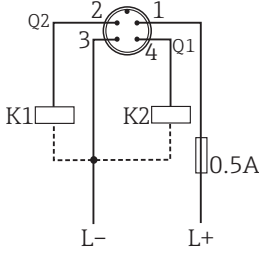









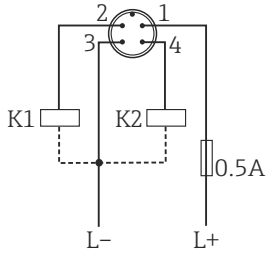
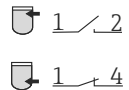

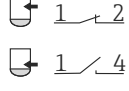

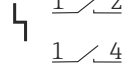

Electrical connection	Both switch outputs active simultaneously ^{1) 2)}
<p>M12 plug</p> 	 <p>1 Supply voltage + 2 DC-PNP (Q2) 3 Supply voltage - 4 DC-PNP (Q1)</p> <p style="text-align: right;">A0035998</p>

- 1) Depending on configuration
- 2) Current consumption with two outputs connected: < 25 mA

Function monitoring

In the order configuration: With two-channel evaluation, functional monitoring of the sensor is also possible in addition to level monitoring, provided that no other monitoring option has been configured via IO-Link.

When both outputs are connected, the MIN and MAX outputs assume opposite states (XOR) when the device is operating fault-free. In the event of an alarm condition or a line break, both outputs are de-energized.

Connection for function monitoring using XOR operation		Yellow LED (ye)	Red LED (rd)										
 <p style="text-align: right;">A0022917</p>	<p>Sensor covered</p> 												
	<p>Sensor uncovered</p> 												
	<p>Fault</p> 												
<table border="0"> <tr> <td>Symbols</td> <td>Description</td> </tr> <tr> <td></td> <td>LED lit</td> </tr> <tr> <td></td> <td>LED not lit</td> </tr> <tr> <td></td> <td>Fault or warning</td> </tr> <tr> <td>K1/K2</td> <td>External load</td> </tr> </table>		Symbols	Description		LED lit		LED not lit		Fault or warning	K1/K2	External load		
Symbols	Description												
	LED lit												
	LED not lit												
	Fault or warning												
K1/K2	External load												

Valve plug

Depending on the assignment of the connector, the device works in either the MAX or MIN mode.

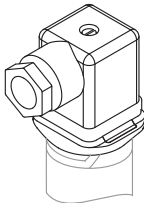
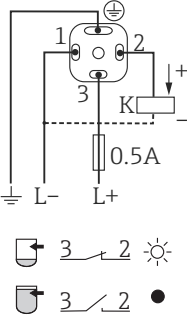
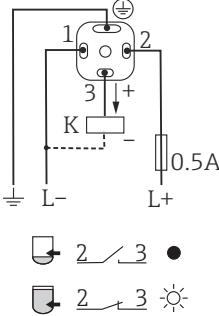
Electrical connection	Mode of operation									
 <p style="text-align: right; font-size: small;">A0022900</p>	MAX	MIN								
										
<table border="0" style="width: 100%;"> <thead> <tr> <th style="text-align: left;">Symbols</th> <th style="text-align: left;">Description</th> </tr> </thead> <tbody> <tr> <td style="text-align: center;">●</td> <td>Yellow LED (ye) not lit</td> </tr> <tr> <td style="text-align: center;">☉</td> <td>Yellow LED (ye) lit</td> </tr> <tr> <td style="text-align: center;">K</td> <td>External load</td> </tr> </tbody> </table>			Symbols	Description	●	Yellow LED (ye) not lit	☉	Yellow LED (ye) lit	K	External load
Symbols	Description									
●	Yellow LED (ye) not lit									
☉	Yellow LED (ye) lit									
K	External load									

Cable specification	<ul style="list-style-type: none"> ■ M12 plug: IEC 60947-5-2 ■ Valve plug <ul style="list-style-type: none"> - Cable cross-section: Max.1.5 mm² (16 AWG) - Ø3.5 to 6.5 mm (0.14 to 0.26 in)
----------------------------	---

Length of connecting cable	<ul style="list-style-type: none"> ■ Max. 25 Ω/core, total capacity < 100 nF ■ IO-Link communication: < 10 nF
-----------------------------------	---

Overvoltage protection	Overvoltage category II
-------------------------------	-------------------------

Performance characteristics

Reference operating conditions	<p>Accuracy in accordance with DIN EN 61298-1 based on 100% (factory adjustment)</p> <ul style="list-style-type: none"> ■ Non-repeatability: ± 1 % ■ Uncertainty, absolute: ± 2.5 % ■ Hysteresis: + 0.5 % ± 0.5 % <p>Horizontal orientation:</p> <ul style="list-style-type: none"> ■ Ambient temperature: 20 °C (68 °F) ±5 °C ■ Medium temperature: 20 °C (68 °F) ±5 °C ■ Process pressure: 1 bar abs. (14.5 psi) ■ Medium: Sliding earthed metal plate in front of sensor.
---------------------------------------	--

Switch-on behavior	< 2 s
---------------------------	-------

Influence of ambient temperature	Maximum 0.1 %/K
---	-----------------

Switch-on delay	< 2 s until correct switch status is set. Prior to that, the switch outputs are in a blocked state.
------------------------	---

Switching delay	<ul style="list-style-type: none"> ■ 0.5 s when sensor is covered ■ 1.0 s when sensor is uncovered ■ IO-Link communication: 0.3 to 60 s configurable ■ Can be ordered as option: 0.3 s; 1.5 s or 5 s (when sensor is covered or uncovered) ¹⁾
------------------------	--

1) See Product Configurator, order code 570, option HS

Installation

Mounting location

Lateral mounting in bulk solids silos, indoors or outdoors, e. g. in silo



For installation in metallic or non-metallic bulk solids silos, follow the EMC guidelines → 11.

Installation instructions

- Engineering unit mm (in)
- Sensor surface ≥ 20 mm (0.79 in) projecting into silo (when installing with weld-in adapter 20 mm (0.79 in))
- Silo wall thickness < 35 mm (1.38 in) or welding socket G 1" < 50 mm (1.97)

Examples

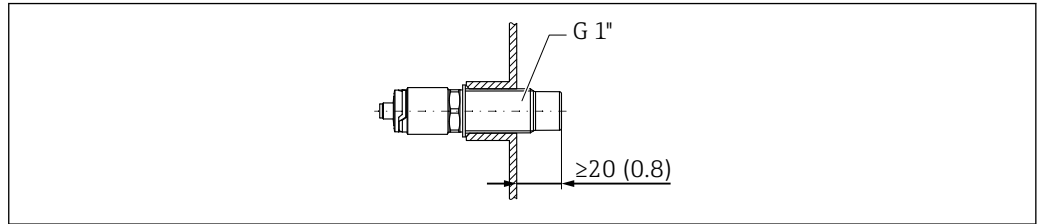

A0035881

2 Standard installation with external G 1" threaded adapter

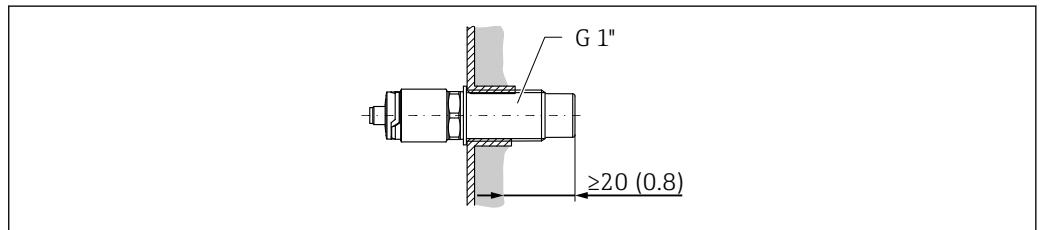

A0036360

3 Where buildup occurs on the silo wall with internal G 1" threaded adapter

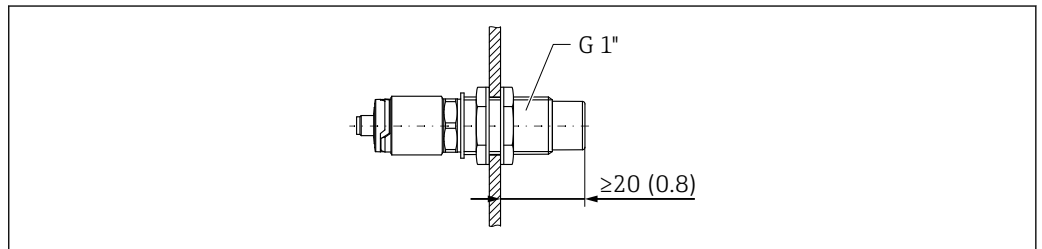

A0036359

4 Bore hole in silo wall with lock nuts, can be ordered as an accessory → 19

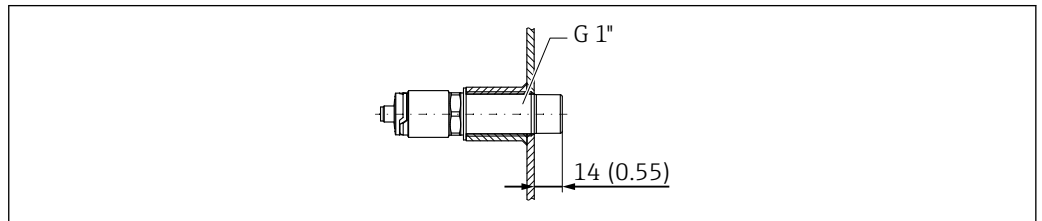

A0036362

5 Installation with weld-in adapter, can be ordered as an accessory → 19

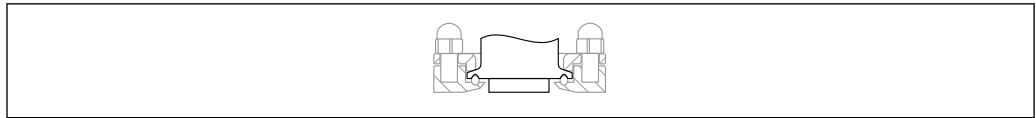

A0036363

- 6 Installation with Tri-Clamp and NA Connect provided by customer, can be ordered as an accessory
→ 19

Installation with protector

- Protection of point level switch against damage by particularly abrasive or coarse product
- Outflow protection in silo for functional testing when silo is full

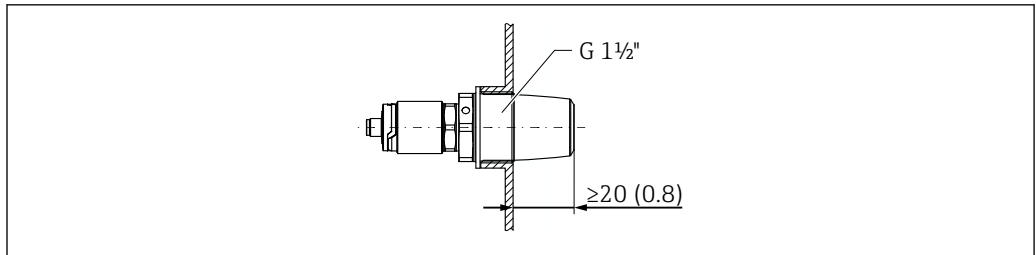

A0036361

- 7 Installation with protector, can be ordered as an accessory → 19

Installation with protection cover

- Installation with protection cover against impact effects or
 - in hazardous area
- Please also ensure compliance with the corresponding national standards and regulations and the Safety Instructions or Installation or Control Drawings → 21
- Fit the protection cover before the device is put into operation.

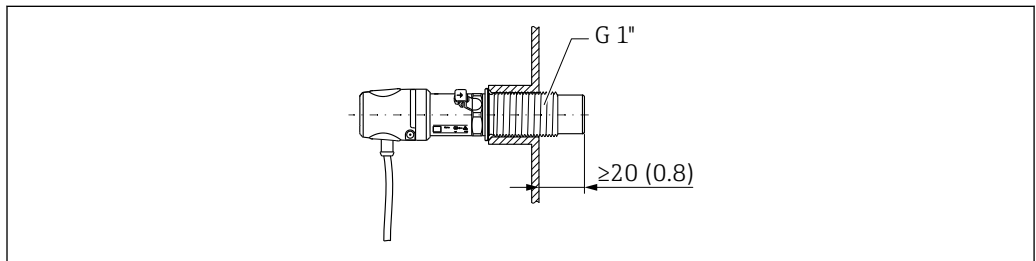

A0036433

- 8 Installation with protection cover, included in scope of delivery for hazardous areas or can be ordered as an accessory → 19

Environment

Ambient temperature range

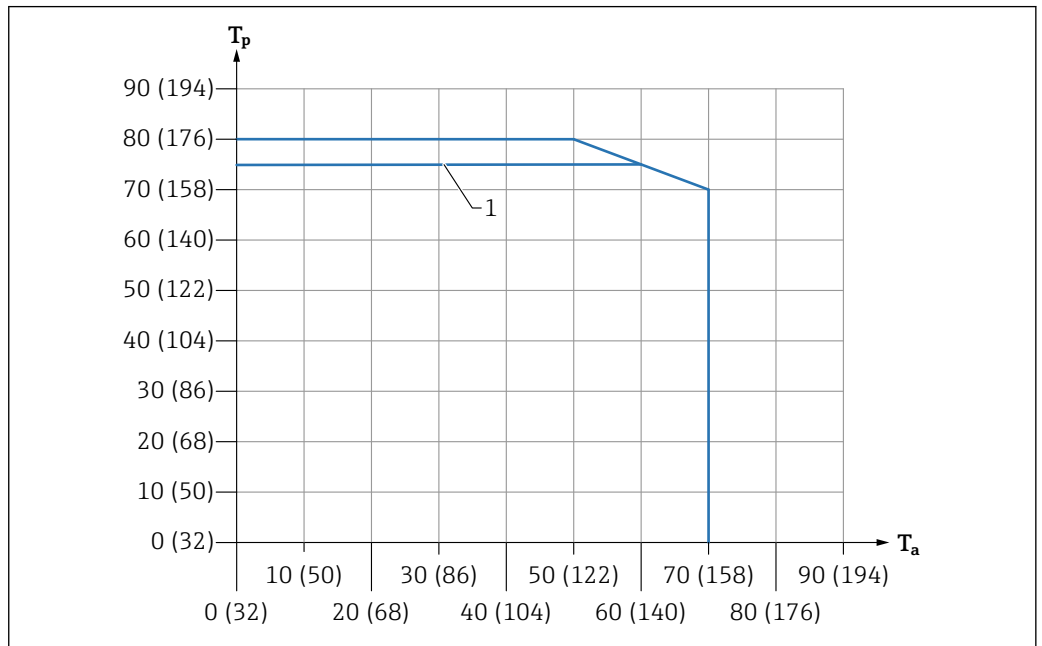

- 1) Ex devices
 Tp) Process temperature = °C (°F)
 Ta) Ambient temperature = °C (°F)

Storage temperature	-25 to +85 °C (-13 to +185 °F) Pressure: 1 bar abs. (14.5 psi)
Relative humidity	0 to 100 %
Climate class	DIN EN 60068-2-38/IEC 68-2-38: Test Z/AD
Altitude	Up to 2 000 m (6 600 ft) above sea level
Degree of protection	<ul style="list-style-type: none"> ■ IP65/67 NEMA Type 4X Enclosure (M12 plug for plastic housing cover) ■ IP66/68/69 NEMA Type 4X/6P Enclosure (M12 plug for metal housing cover) ■ IP65 NEMA Type 4x Enclosure (ISO4400 M16/NPT ½" valve plug for plastic housing cover)
Shock resistance	In accordance with EA inspection, prEN 60068-2-27:2007: a = 300 m/s ² = 30 g, 3 planes x 2 directions x 3 shocks x 18 ms
Vibration resistance	In accordance with Fh inspection, EN 60068-2-64:2008: a(RMS) = 50 m/s ² , f = 5 to 2 000 Hz, t = 3 planes x 8 h
Cleaning	Resistant to typical cleaning agents from the outside. Passed Ecolab test.
Electromagnetic compatibility	<p>The electromagnetic compatibility requirements outlined in the IEC/EN 61326 series for "industrial environments" are fulfilled when the device is installed in metallic vessel or metallic pipes. Emission requirements for class B equipment are met. For details, refer to the Declaration of Conformity.</p> <p>If the device is installed in plastic structures, its function may be influenced by strong electromagnetic fields. Emission requirements for class A equipment are met (only for use in "industrial environments").</p>
Reverse polarity protection	Integrated; no damage in the event of reverse polarity or short-circuit

Short-circuit protection

- Overload protection/short-circuit protection at $I > 200$ mA
- IO-Link communication: 105 mA each if both switch outputs are active

Intelligent monitoring: Testing for overload at intervals of approx. 1.5 s; normal operation resumes once the overload/short-circuit has been rectified.

Process

Process temperature range

-20 to +80 °C (-4 to +176 °F)

For Ex devices: -20 to +75 °C (-4 to +167 °F)

Process pressure range

-1 to +6 bar (-14.5 to +87 psi)

Process fluid

Powdery and fine-grained bulk solids

- Grain size < 10 mm
- Dielectric constant 1.3
- Default values: $\epsilon_r > 1.6$ with protector, $\epsilon_r > 2.0$ without protector

Mechanical construction

i Exact dimensions are available in the Product Configurator on the Endress+Hauser website: www.endress.com → Product finder → On the product page, click the "Configure" button to the right of the product photo.

Engineering unit mm (in)

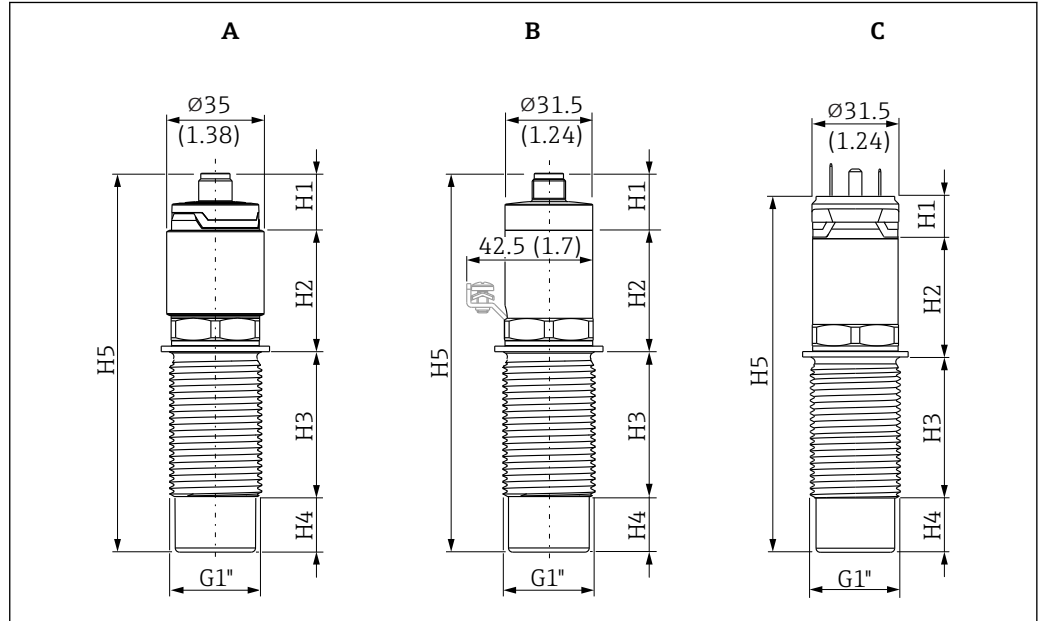

A0036387

- A Nivector FTI26 plastic with M12 plug
- B Nivector FTI26 stainless steel with M12 plug, with optional ground terminal
- C Nivector FTI26 stainless steel with valve plug

Height measurement	Designation	A	B	C
H1	Housing cover	20.5 (0.81)		16 (0.36)
H2	Housing	43.6 (1.72)		
H3	Process connection	52 (2.05)		
H4	Sensor	20 (0.79)		
H5	Nivector FTI26 overall dimensions	136 (5.35)		131.2 (5.17)

i Additional accessories for hygiene sector and hazardous areas: weld-in adapter G 1", Tri-Clamp 2", protection cover → 19

Connector

Dimensions mm (in)

Connection plug with PPSU plastic housing cover

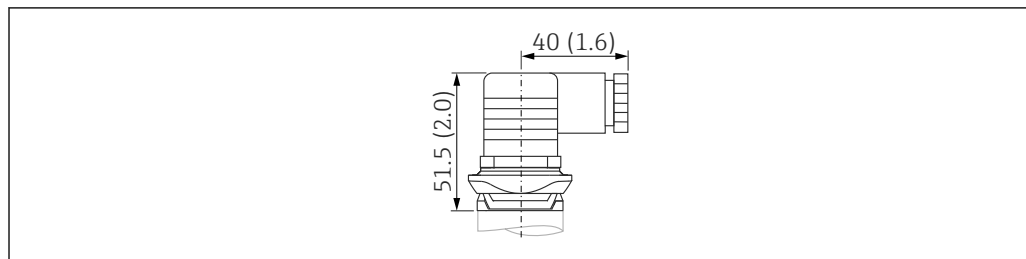

A0021859

9 Valve plug M16, NPT 1/2"

Weight

- Plastic with M12 plug: 118 g (4.162 oz)
- Plastic with valve plug: 120 g (4.232 oz):
- Stainless steel with M12 plug: 240 g (8.465 oz):
- Stainless steel with valve plug: 243 g (8.465 oz)
- Stainless steel with M12 plug and protection cover: 288 g (10.158 oz)

Materials*Wetted materials*

Component part	Material	Product Configurator
Sensor	316L (1.4404), ECTFE ¹⁾	Order code 110, option WDJ
	Polycarbonate	Order code 110, option WDG
Protector G 1 1/2"	Material PBT-GF ²⁾	Order code 620, option PA
Protector R 1 1/2"	O-ring EPDM	Order code 620, option PB

1) The material ECTFE meets the requirements of EU 1935/2004, 10/2011, 2023/2006 and FDA 21 CFR 177.1380

2) The material meets the requirements of EU 1935/2004, 10/2011, 2023/2006 and FDA 21 CFR 177.1660

Materials not in contact with process

Component part	Material	Product Configurator
Process connection	316L (1.4404/1.4435)	Order code 110, option WDJ
	Polycarbonate	Order code 110, option WDG
Lock nut	PA (black)	Order code 620, option R7
Housing cover, valve plug	PPSU Design ring: PBT/PC	Order code 40, option U, V
M12 housing covers	316L (1.4404/1.4435)	Order code 40, option N
	PPSU Design ring: PBT/PC	Order code 40, option M
Housing	316L (1.4404/1.4435)	Order code 110, option WDJ
	Polycarbonate	Order code 110, option WDG
Nameplate	lasered onto housing	-
Ground terminal (optional)	304 (1.4301)	See Ex approval, order code 10 → 21
Protection cover (optional)	Polycarbonate	See Ex approval, order code 10 → 21

i Endress+Hauser supplies DIN/EN process connections with threaded connection in stainless steel in accordance with AISI 316L (DIN/EN material number 1.4404 or 14435). In terms of their stability-temperature property, the materials 1.4404 and 1.4435 are grouped in EN 1092-1 table 18 under 13E0. The chemical composition of the two materials can be identical.

Surface roughness	Sensor surface in contact with process: $R_a \leq 0.76 \mu\text{m}$ (30 μin), ordering information: Product Configurator order code for "Process connection" option "WDJ"
--------------------------	---

Operability

Operating concept for devices with IO-Link

Operator-oriented menu structure for user-specific tasks

Quick and safe commissioning

Guided menus for applications

Reliable operation

Operation in the following languages:
Via IO-Link: English

Efficient diagnostic behavior increases measurement availability

- Remedial measures
- Simulation options

IO-Link information

IO-Link is a point-to-point connection for communication between the measuring device and an IO-Link master. The measuring device features an IO-Link communication interface type 2 with a second IO function on pin 4. This requires an IO-Link-compatible assembly (IO-Link master) for operation. The IO-Link communication interface enables direct access to the process and diagnostic data. It also provides the option of configuring the measuring device while in operation.

Physical layer, the measuring devices supports the following features:

- IO-Link specification: version 1.1
- IO-Link Smart Sensor Profile 2nd Edition
- SIO mode: yes
- Speed: COM2; 38.4 kBaud
- Minimum cycle time: 6 msec.
- Process data width: 16 bit
- IO-Link data storage: yes
- Block configuration: no

IO-Link download

<http://www.endress.com/download>

- Select "Software" as the media type.
- Select "Device Driver" as the software type.
Select IO-Link (IODD).
- In the "Text Search" field enter the device name.

<https://ioddfinder.io-link.com/>

Search by

- Manufacturer
- Article number
- Product type

Light signals (LEDs)

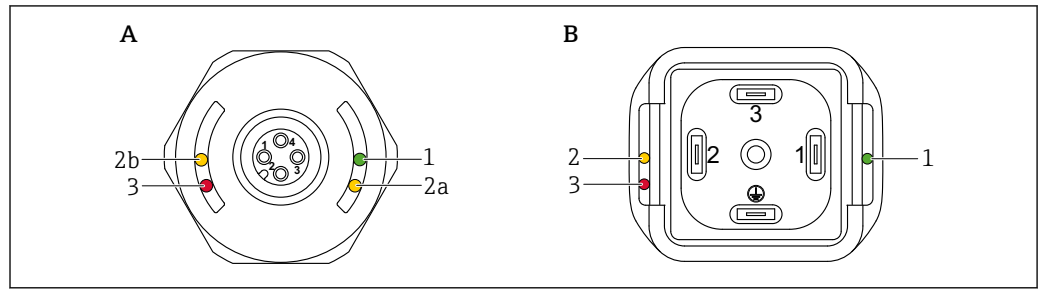

A0036482

10 Position of LEDs on housing cover

A Housing cover with M12 plug, plastic

B Housing cover with valve plug

i There is no external signaling via LEDs on the metal housing cover (IP69). A connecting cable with an M12 plug and LED display can be ordered as an accessory if necessary. This cable has no red LED. See "Accessories".

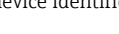
Position	LEDs	Description of function
1	Green LED (gn)	<p>Lit: Measuring device is operational</p> <p>In conjunction with IO-Link communication:</p> <ul style="list-style-type: none"> lit: SIO mode flashing: Active communication, flash frequency  flashes with increased luminosity: Device search (device identification), flash frequency 
2	Yellow LED (ye)	<p>M12 plug LED 2a Active only in conjunction with IO-Link communication.</p> <p>LED 2b display of sensor status Sensor is covered by medium.</p>
		<p>M12 plug in conjunction with IO-Link communication: LED 2a switch status/switch output 2 Following customer adjustment: Sensor is covered by medium 1. LED 2b switch status/switch output 1 Following customer adjustment: Sensor is covered by medium 2.</p>
		<p>Valve plug: Indicates switch status MAX mode (overflow protection): Sensor is not covered by medium MIN mode (dry-running protection): Sensor is covered by medium</p>
3	Red LED (rd)	<p>Warning/Maintenance required flashing: Error remediable, e. g. invalid calibration Fault/device failure lit: Error not remediable, e. g. Electronics error Diagnostics and troubleshooting</p>

Device search

IO-Link communication: The Device search parameter is used to uniquely identify the device during installation.

Sensor check

IO-Link communication: The Sensor check parameter checks if the sensor system is functioning correctly. The sensor must not be covered and must be free of residue.

Medium calibration

Empty/full calibration are carried out with the test magnet or by means of IO-Link communication. The threshold is defined automatically following calibration. The thresholds can also be adjusted manually in the case of IO-Link.

Function test

The test magnet is used to invert the current switch status.

i The test magnet is included in the scope of delivery. It is also possible to cancel it → 20.

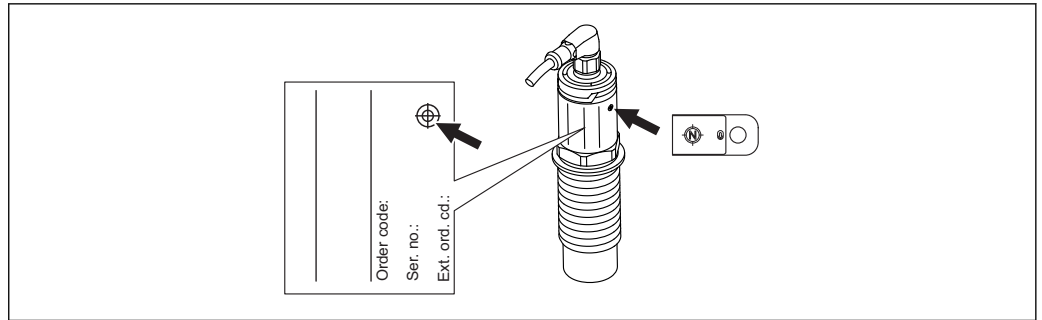

A0035882

11 Position for test magnet on housing nameplate

Certificates and approvals

 Currently available certificates and approvals can be called up via the product configurator.

CE mark

The measuring system is in conformity with the statutory requirements of the applicable EC Directives. These are listed in the corresponding EC Declaration of Conformity along with the standards applied. Endress+Hauser confirms successful testing of the device by affixing to it the CE mark.

C-tick symbol

The measuring system complies with EMC requirements of the "Australian Communications and Media Authority (ACMA)".

RoHS

The measuring system complies with the substance restrictions of the Restriction on Hazardous Substances Directive 2011/65/EU (RoHS 2).

RCM-Tick marking

The supplied product or measuring system meets the ACMA (Australian Communications and Media Authority) requirements for network integrity, interoperability, performance characteristics as well as health and safety regulations. Here, especially the regulatory arrangements for electromagnetic compatibility are met. The products are labelled with the RCM- Tick marking on the name plate.



A0029561

EAC conformity

The measuring system meets the legal requirements of the applicable EAC guidelines. These are listed in the corresponding EAC Declaration of Conformity together with the standards applied. Endress+Hauser confirms successful testing of the device by affixing to it the EAC mark.

Pressure equipment with allowable pressure ≤ 200 bar (2 900 psi)

Pressure instruments with a flange and threaded boss that do not have a pressurized housing do not fall within the scope of the Pressure Equipment Directive, irrespective of the maximum allowable pressure.



Reasons:

According to Article 2, point 5 of EU Directive 2014/68/EU, pressure accessories are defined as "devices with an operational function and having pressure-bearing housings".

If a pressure instrument does not have a pressure-bearing housing (no identifiable pressure chamber of its own), there is no pressure accessory present within the meaning of the Directive.

Ex approval

The devices are certified for use in hazardous areas and the relevant safety instructions are provided in the separate "Safety Instructions" (XA01734F) document. Reference is made to this document on the nameplate.

 You will find information on the available certificates in the supplementary documentation section →  21

Sanitary compatibility

The device has been developed for use in hygienic processes. The process-wetted materials meet the requirements stipulated in EU 1935/2004, 10/2011, 2023/2006 and FDA 21 CFR 177.2415 (only for order code for "Process connection", option "WDJ").

By affixing the 3-A symbol to the device, Endress+Hauser confirms compliance with the 3-A Sanitary Standard No. 74-xx and No. 50-xx.

The following certificate copies can be ordered with the device (optional): →  18

3-A



A0037165

EHEDG

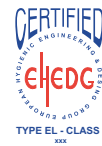

- To avoid the risk of contamination, install the device in accordance with the design principles of EHEDG, Document 37 "Hygienic Design and Application for Sensors" and Document 16 "Hygienic Pipe Connections".
- Suitable connections and seals must be used in order to guarantee a hygienic design in accordance with the specifications of 3-A and EHEDG.
- Information on 3-A and EHEDG-approved weld-in adapters can be found in the "Weld-in adapter, process adapter and flanges" documentation, TI00426F/00/EN.

Hygiene approval

Process connections	Option ¹⁾	EHEDG	3-A
ISO228 G1" thread, 316L in conjunction with Tri-Clamp 2" process adapter	WDJ + PI	✓	✓
ISO228 G1" thread, 316L in conjunction with G1" weld-in adapter	WDJ + RI	✓	✓

1) See order code in Product Configurator

Manufacturer's Declaration

The following documents can be ordered with the device (optional):

- FDA conformity
- Regulation (EC) No. 1935/2004 on materials and articles intended to come into contact with food

Ordering information

Detailed ordering information is available from the following sources:

- In the Product Configurator on the Endress+Hauser website: www.endress.com -> Click "Corporate" -> Select your country -> Click "Products" -> Select the product using the filters and search field -> Open product page -> The "Configure" button to the right of the product image opens the Product Configurator.
- From your Endress+Hauser Sales Center: www.addresses.endress.com

 Product Configurator - the tool for individual product configuration

- Up-to-the-minute configuration data
 - Depending on the device: Direct input of measuring point-specific information such as measuring range or operating language
 - Automatic verification of exclusion criteria
 - Automatic creation of the order code and its breakdown in PDF or Excel output format
 - Ability to order directly in the Endress+Hauser Online Shop

Accessories

- Accessories can be ordered with the device (optional) or separately.
- The adapters are also available with inspection certificate 3.1 EN10204. For more information on process adapters and weld-in adapters, please refer to the supplementary documentation → 21.

Adapter

- For hygiene sector and hazardous areas
- Material: 316L (1.4404), seal: EPDM 70
- Weight: 265 g (9.347 oz.)
- Order number Tri-Clamp 2": 71395793
- Order number weld-in adapter G 1": 71395797

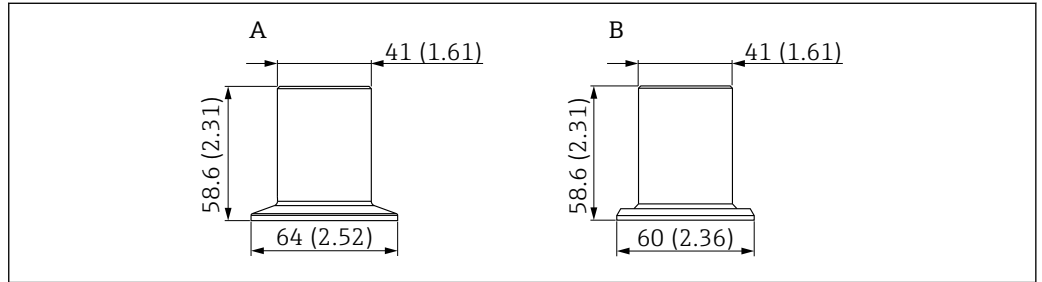

A0036229

A Tri-Clamp 2", order code 620, option RI
 B Weld-in adapter G 1", order code 620, option PI

Protector G 1½", R 1½"

	G 1½"	R 1½"
Material	PBT-GF	PBT-GF
Weight	74 g (2.610 oz)	71 g (2.504 oz)
Order number	71395785	71395862
Order code 620, option:	PA	PB

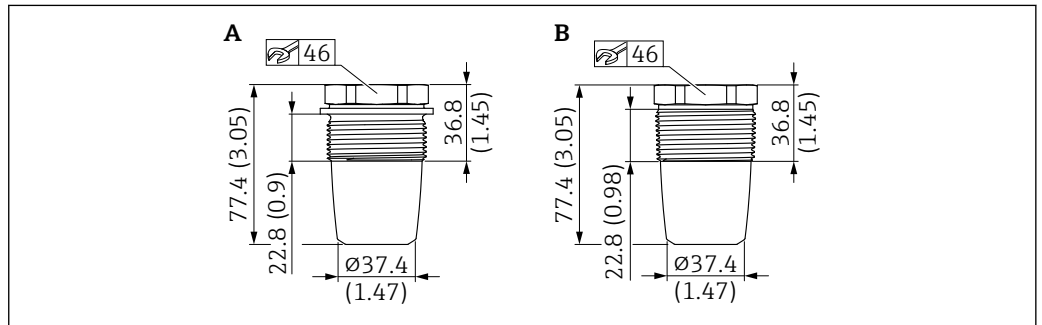

A0035938

A G 1½"
 B R 1½"

Lock nut

- Material: PA
- Order number: 71395801

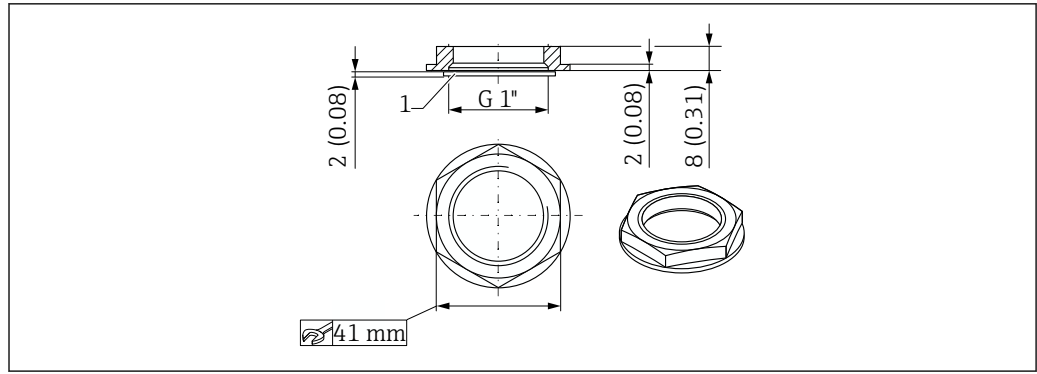

A0036041

Protection cover

- Material: PC
- Order number: 71395803

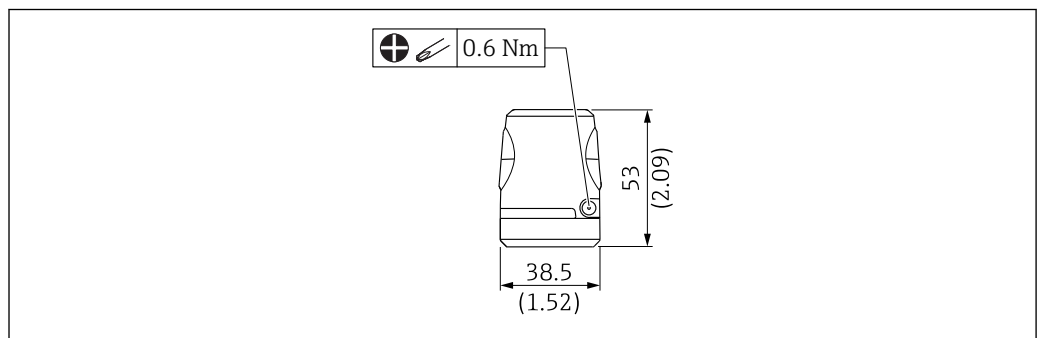

A0036434

Test magnet

Order number: 71267011

Plug-in jack, connection adapter

Designation		Order number	Option ¹⁾
Cable, plug-in jack Engineering unit mm (in) Example: M12 with LED	M12 IP69 with LED <ul style="list-style-type: none"> ■ Elbowed 90°, terminated at one end ■ 5 m (16 ft) PVC cable (orange) ■ Body: PVC (transparent) ■ Slotted nut 316L 	52018763	RX
	M12 IP69 without LED <ul style="list-style-type: none"> ■ Elbowed 90°, terminated at one end ■ 5 m (16 ft) PVC cable (orange) ■ Body: PVC (orange) ■ Slotted nut 316L (1.4435) 	52024216	RW
	M12 IP67 without LED <ul style="list-style-type: none"> ■ Elbowed 90° ■ 5 m (16 ft) PVC cable (gray) ■ Slotted nut Cu Sn/Ni ■ Body: PUR (blue) 	52010285	RZ
	M12 IP67 without LED <ul style="list-style-type: none"> ■ Straight, self-terminated connection to M12 plug ■ Slotted nut Cu Sn/Ni ■ Body: PBT 	52006263	R1
Wire colors for M12 plug: 1 = BN (brown), 2 = WT (white), 3 = BU (blue), 4 = BK (black)			

1) See order code in Product Configurator

Supplementary documentation



For an overview of the scope of the associated Technical Documentation, refer to the following:

- *W@M Device Viewer* (www.endress.com/deviceviewer): Enter the serial number from nameplate
- *Endress+Hauser Operations App*: Enter the serial number from the nameplate or scan the 2D matrix code (QR code) on the nameplate

Operating Instructions

- BA01830F → Nivector FTI26
- BA01832F → Nivector FTI26, IO-Link

Supplementary documentation

- TI00426F/00/DE → Weld-in adapters, process adapters and flanges (overview)
- SD01622Z/00/YY → Weld-in adapter (assembly manual)
- SD00356F/00/EN → Valve plug (assembly manual)
- SD02242F/00/A2 → Protector (Installation Instructions)

Certificates

Approval	Documentation code	Order code 10, option:
ATEX II 1/3D Ex ta/tc IIIC T100°C Da/Dc CSA AEx/Ex ta/tc IIIC T100°C Da/Dc EAC Ex ta/tc IIIC T100°C Da/Dc X IECEX Ex ta/tc IIIC T100°C Da/Dc	XA01734F	BO, CO, GO, IO

Registered trademarks



is a registered trademark of the IO-Link company group.



www.addresses.endress.com
